

G
78

FLUKE
Now Incorporating
PHILIPS

PHILIPS

Programmable Timer-Counters PM 6652C...54C

Operators' Manual

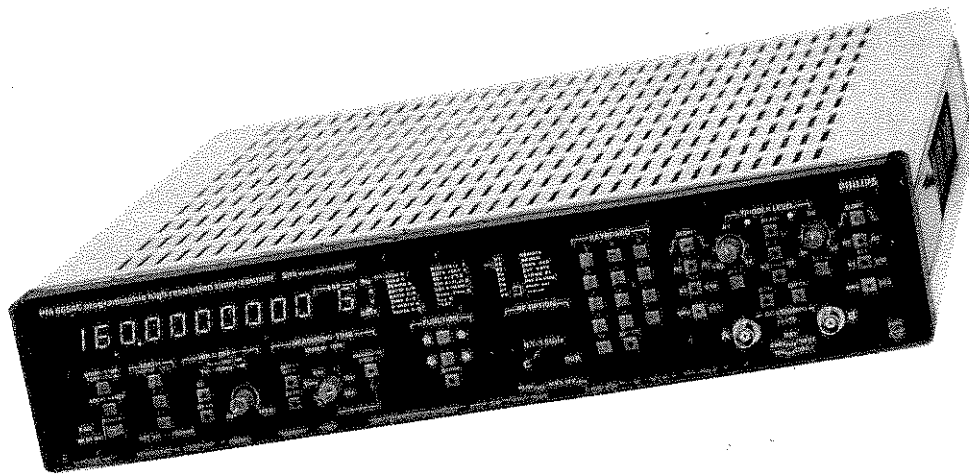

CONTENTS

	Chapter
Introduction	1
Installation	2
Control panels	3
Practical measurements	4
IEEE - 488 BUS interface	5
Other options	6
Measurement theory	7
Performance check	8
Technical specification	9
Addendum PM 9619	10



Chapter 1

INTRODUCTION

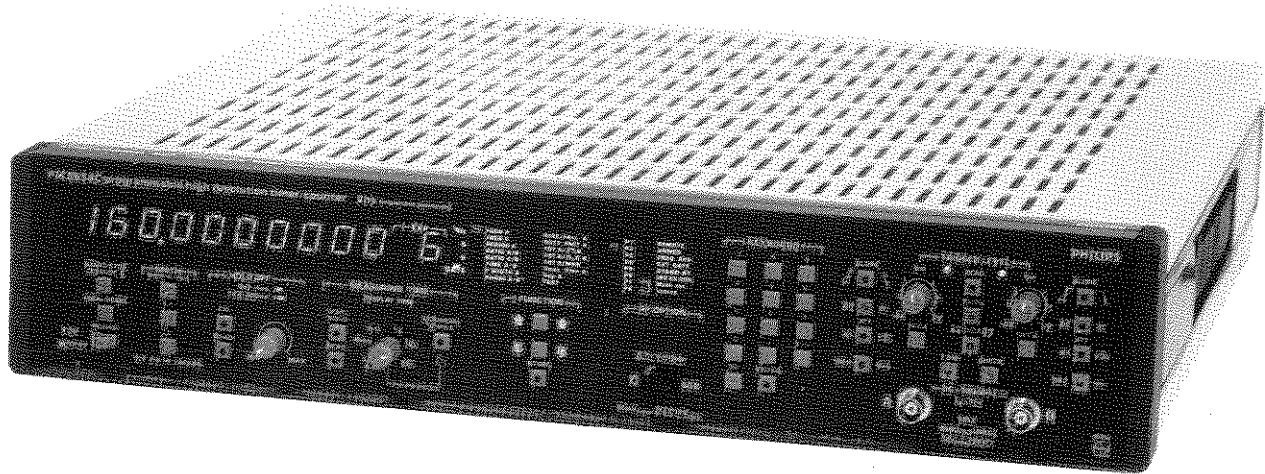

INTRODUCTION

The Philips high performance timer/counters PM 6652, PM 6654, PM 6652C and PM 6654C are fully programmable and satisfy most frequency and time measurement requirements. The four instruments look the same; the differences being found in resolution, accuracy and measuring speed.

The PM 6652 and PM 6652C have a 10 MHz (100 ns) clock frequency, whereas the extra high resolution PM 6654 and PM 6654C features a 500 MHz (2 ns) real time clock.

Thanks to their short measuring cycle times, the PM 6654 and PM6654C are particularly well suited to high speed automatic test systems.

The 'C'-version, introduced in 1986, have new features added to those of the original PM 6652 and PM 6654. A note is made if a function described in this manual is not applicable to the original PM 6652,-54.

All units are also available in blind panel versions.

Choice of crystal oscillators

The choice of crystal oscillators ranges from a standard oscillator to the $5 \times 10^{-10}/24$ h oven stabilized oscillator PM 9691. The high stability crystal oscillators are available as options for later upgrading of the counters.

High measuring power

The two timer/counters feature 14 different measuring modes: everything found in conventional counters, plus extra functions such as: PHASE, (directly in degrees), RISE/FALL TIME, DUTY FACTOR and VOLT.

FREQUENCY and PERIOD measurements are made very rapidly. The PM 6654 needs only one second for a 9 digit resolution while the PM 6652, in the same time, gives 7 digits. Both models perform measurements such as burst frequency, multiple burst frequency average and externally gated frequency measurements.

Trigger HOLD-OFF can be activated in frequency and period modes. It inhibits stop triggering during an adjustable hold-off time after start of the measurement, to avoid false triggering due to noise or interference (e.g. relay bounce).

Mathematics

The mathematic facilities of scaling and/or off-setting the measuring result extends the application possibilities. Some examples:

- V_{pp} measurements can be converted to V_{RMS} .
- Frequency readings from a transducer can be calibrated as RPM.
- Liters/s, gallons/min or m/s.
- Phase measurements can be converted from degrees toadians.

Time interval measuring accuracy

The PM 6654 with 2ns single shot resolution allows time interval measurements with a very high accuracy and resolution. Averaging a large number of measuring results in time interval, pulse width or rise or fall time modes gives a resolution of less than one picosecond with the PM 6654 and down to 10ps with the PM 6652.

Trigger accuracy

The PM 6652/54 inputs feature 1ns rise times and 20mV sensitivity over a -5V...+5V range. The counter can simultaneously display the set trigger levels of both the A and B channels. What appears on the display are the real trigger points. Automatic hysteresis compensation enables triggering at the set trigger level. Systematic trigger errors are thus kept to an extremely low level.

The PM 6652/54 gives full control over defining start and stop triggering. Arming and trigger hold-off enable rejection of unwanted signals which would otherwise trigger the counter.

Simple programming of IEEE-488 bus performance

The PM 6652/6654 are fully programmable, including all trigger controls. The optional interface card PM 9696 allows bus operations at a low additional cost. The resolution and measuring speed of the PM 6652/54 can be fully exploited by using the high speed dump mode, allowing up to 400...500 measurements per second. The IEEE 728/IEC-625-2 code and format norms are fully implemented in these counters.

The PM 6652/6654 can write their own program messages. First one finds the best control settings for a measurement. Thereafter activate the BUS LEARN mode, and the counter sends the status of all manually set controls to the controller. This eliminates the risk of programming errors and the need for debugging.

The eight "stored panel programs" P1...P8 can also be selected and created via the bus. This requires only one message and greatly reduces the bus communication load.

In "ST BY", power is available for an oven stabilized oscillator.

A 10 digit DISPLAY for the measuring result and for digital readout of: measuring time, hold off time, trigger levels and mathematical constants K/L. Exponential notation and unit indicators.

Reset the display and initiate new measurement.

Totalize events by manual Start/Stop (TOT A MAN).

Cursor indication of set function, or set "STORED PANEL PROGRAM" P1...P8, even when operated via the IEEE-488 BUS.

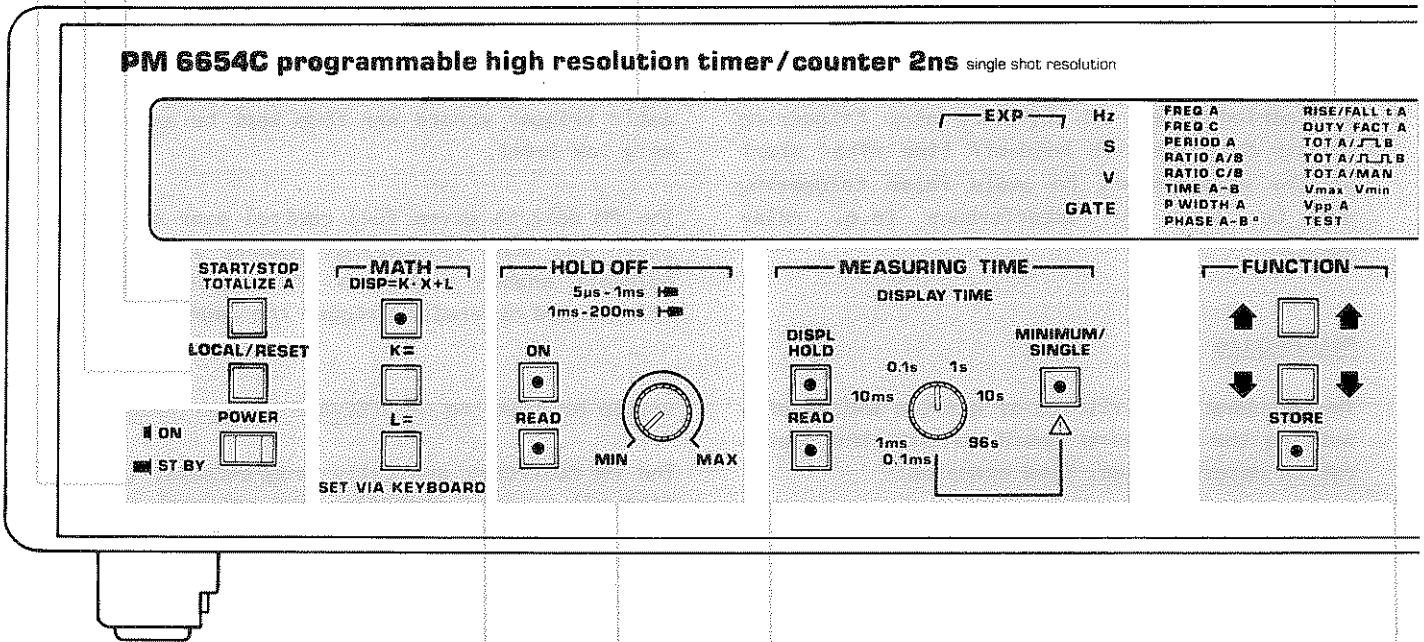

Set mathematical constants K and L for conversion of the displayed results.

Move the Function Cursor up or down to select the function to be used. Also select stored panel programs P1...P8.

Prevents false stop triggering due to spurious signals.

Store the current control panel settings in a "STORED PANEL PROGRAM" P1...P8.

Acts also as a variable low pass filter in the range 5 Hz...150 kHz.

Set the MEASURING TIME between 0.1 ms and 96 s. Select MINIMUM/SINGLE for shortest measuring time or a single measurement. READ the set time on the display. DISPLAY HOLD freezes the display and inhibits new measurements unless reset.

Indication of selected "STORED PANEL PROGRAM".

Input controls: slope, AC/DC coupling, attenuator, impedance, and separate/common.

Indication of rear panel settings, remote operation and stand by.

Set trigger levels via keyboard or automatic or potentiometers.

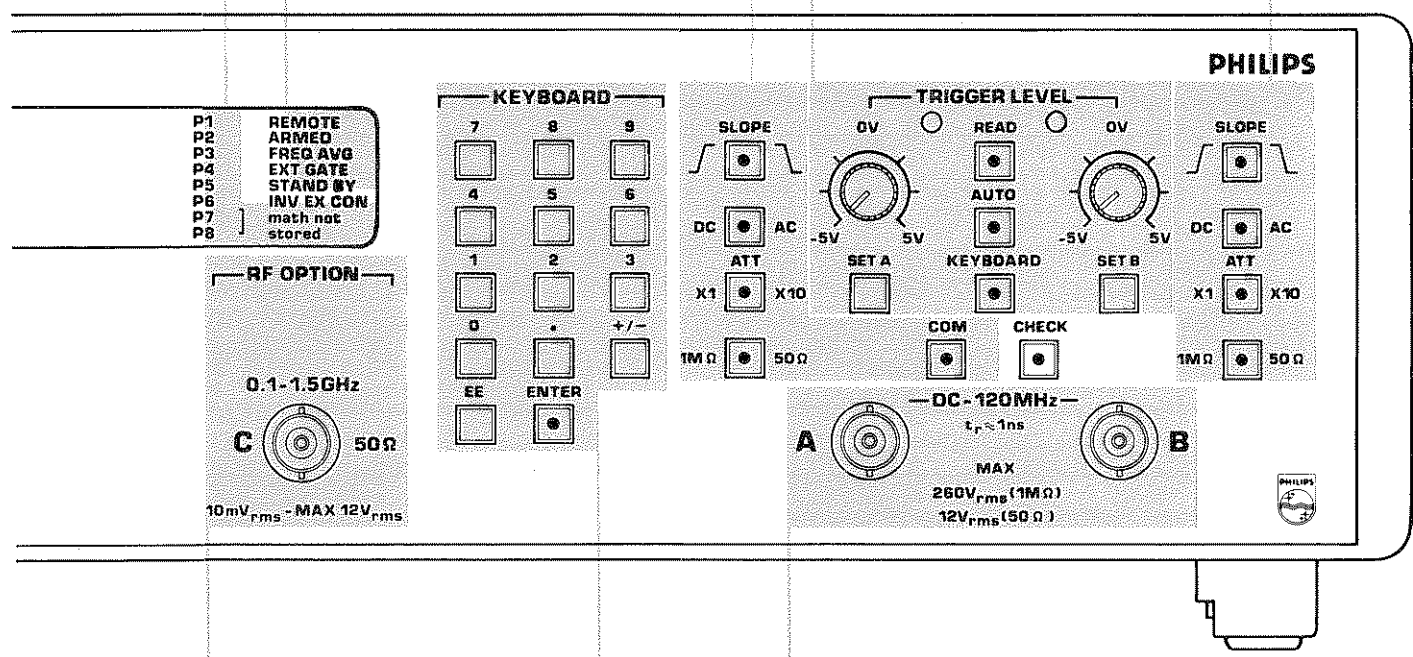

P1 REMOTE
P2 ARMED
P3 FREQ AVG
P4 EXT GATE
P5 STAND BY
P6 INV EX CON
P7 math not
P8 stored

RF OPTION
0.1-1.5GHz
C 50Ω
10mV_{rms} - MAX 12V_{rms}

KEYBOARD
7 8 9
4 5 6
1 2 3
0 + -
EE ENTER

TRIGGER LEVEL
SLOPE 0V READ 0V
DC AC -5V 5V
ATT X1 X10
X1 X10
1MΩ 50Ω
COM CHECK
SET A SET B
KEYBOARD

DC-120MHz
t_r ≈ 1ns
MAX
250V_{rms} (1MΩ)
12V_{rms} (50Ω)
A B
PHILIPS

A and B input channels.

Enter trigger levels and K/L constant values.

INPUT C optional
0.1...1.5 GHz RF signal input with automatic attenuator.

REAR PANEL
AC or DC Power Inputs.
10 MHz reference input/output.
Arming, Frequency Average, Ext Gate, Remote cursor control, Ext Reset inputs.
Gate Open and Trigger Level outputs.
OPTIONAL: Auxiliary Inputs.
OPTIONAL INTERFACES: IEEE-488 BUS or Analog output.



Chapter 2

INSTALLATION

CONTENTS	Page
General information	2-2
Grounding	2-2
Opening of the cabinet	2-2
Line voltage setting	2-2
External battery operation	2-2
Fuses	2-2
Operating position	2-3
Power switch	2-3
The POWER ON test	2-3

General information

This counter has been designed and tested in accordance with IEC Publication 348, Safety Requirements For Electronic Measuring Apparatus For Class 1 Instruments, and has been supplied in a safe condition. This manual contains information and warnings that should be followed by the user to ensure safe operation and to keep the counter in a safe condition.

Before connecting the counter to the line (mains), visually check the cabinet, controls, connectors, etc, to ascertain whether any damage has occurred in transit. If any defects are apparent, do not connect the counter to the line. All components on the primary side of the line transformer are CSA approved and should only be replaced with original parts.

In the event of obvious damage, missing parts or if the safety of the counter is suspected, a claim should be made to the carrier immediately. A PHILIPS Sales or Service organisation should also be notified in order to facilitate the repair of the counter.

Grounding

The counter is connected to ground via a sealed three-core line cable, which must be plugged into a socket outlet with a protective ground contact. No other method of safety grounding is permitted for this counter. When the counter is brought from a cold to a warm environment, condensation may cause a hazardous condition. Therefore, ensure that the grounding requirements are strictly met.

Any interruption of the protective ground, inside or outside the counter, is dangerous. Line extension cables must always have a protective ground conductor.

Opening of the cabinet

The counter must be disconnected from all voltage sources before it is opened. If adjustment or maintenance of the counter with the covers

removed is inevitable, such maintenance must be carried out only by a qualified person. Bear in mind that capacitors inside the counter may still retain their charge, even if the counter is disconnected from all voltage sources.

Opening of the cabinet or removing of parts, except those to which access can be gained by hand, is likely to expose live parts and accessible terminals that can be dangerous to life.

Line voltage setting

Before connecting the counter to the line, ensure that it is set to the local line voltage. On delivery, the counter is set to either 115V or 230V, as indicated on the line voltage selector on the rear panel (note that the selector shows 220V). If the voltage setting is incorrect, set the line voltage selector in accordance with the local voltage before connecting the counter to the line.

WARNING: If the counter has accidentally been connected to a 230V supply when set to 115V, an internal safety circuit and the line (mains) fuse will blow. These components have to be replaced afterwards. See service manual.

External battery operation

For field applications, the PM 6652 and PM 6654 can be modified for 24V DC on request. Use cable connector 4822 266 20014.

Note: Center pin in the connector should have + polarity.

Fuses

The counter is protected by two fuses. The primary fuse has to be changed when the mains voltage setting is changed. For 230V use a 0.4A delayed action fuse and for 110V use 0.8A delayed action. The secondary fuse on the PC-board unit 2 shall be a 4A fast action. Remove the line plug before fitting a fuse. Ensure that only fuses of the specified type are used.



Chapter 3

CONTROL PANELS

CONTENTS	Page
An introduction to operating PM 6652-54	3-2
Control panel logic	3-5
Description of controls	3-6
Rear panel controls and connectors	3-10

AN INTRODUCTION TO OPERATING THE PM 6652/54

This brief introductory guide has been created to avoid the use of lengthy texts to describe the various operating characteristics of the PM 6652/54 Timer/Counters. In it, the first time user is taken on a step by step exercise, using most of the controls and indicators, and having any doubtful points explained.

Note: Before applying power, ensure that the installation checks have been carried out (chapter 2).

- 1 Before switching on, look at the STAND BY indicator at the far right of the display panel. It is lit, indicating that instruments fitted with an oven stabilised oscillator have power supplied to the oscillator.
- 2 Switch on, and watch the self-test program run (see "Installation").
- 3 Switch off again, then find the rear panel switch marked "INT". Put this switch into the EXT (down) position.
- 4 Switch on again. The self-test program will end with E4 - a measuring logic circuit error. Put the INT/EXT switch back to INT, then press RESET. Alternatively, put the switch back to INT, then switch the power off and on again. The effect is the same.
- 5 Make sure that there are no input signals connected.
- 6 Find the function display above the three pushbuttons marked FUNCTION. The arrow cursor should be pointing to FREQ A. It doesn't matter if it isn't, but if the "function" cursor is pointing to some other function, then there will also be another cursor on the P1...P8 indicator column. This shows that a "stored panel program" is active.

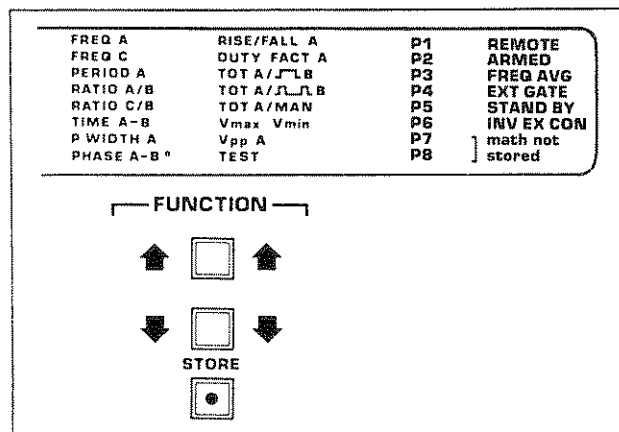

- 7 Push the FUNCTION buttons (marked with arrows), and see how the function cursor "steps through" the list of functions. (It won't stop at the channel C functions unless the channel C option is fitted). Note how, when the function cursor passes FREQ A (going up) or TEST (going down), the P8 or P1 cursor lights. Also note that when a P is indicated, the "program" cursor is the one that steps up and down in response to the FUNCTION buttons, while the "function" cursor moves in accordance with the function that was set in the program. Don't touch STORE yet.
- 8 Press the UP or DOWN buttons continuously, and note how the cursor(s) "scroll", with the "function" cursor hesitating at FREQ A and TEST (to give the operator time to release the button).
- 9 Set the function cursor to FREQ A, with no program active (no P indicated). Then turn the power off and on.
- 10 Look across at the input signal and TRIGGER LEVEL control groups (to the right). Channel A AC coupling and AUTO triggering should be selected (LEDs lit). The instrument will always select these two controls for any "manual" measurement (i.e., no stored panel program P1...P8).

- 11 Press READ. The values on the display are the trigger levels for AUTO mode. There is no input signal, so they will both be 0.01V (or, possibly, varying between 0.01 and 0.02).
- 12 Press AUTO (LED goes off). The trigger levels shown now are those set on the two variable potentiometers. Turn them.
- 13 Press KEYBOARD. The values on the display are the "keyboard" trigger level values (they should be zero). Enter two new values.
- 14 Press SET A. The ENTER light on the keyboard will glow steadily. Make an entry, noting that the enter LED begins flashing as soon as the first digit is entered. When complete, press ENTER (RESET clears ENTER at any time up to that last press). Now set B.
- 15 The values entered on the keyboard will be used whenever KEYBOARD is selected.
- 16 Turn the power off, then on again.
- 17 Select KEYBOARD and READ. The "keyboard" trigger levels have been lost (they were never put into a program - that comes later).

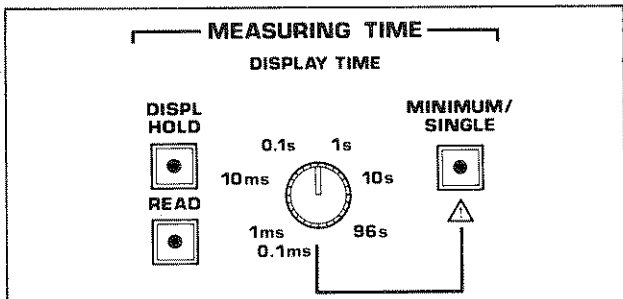

- 18 Move to the MEASURING TIME group of controls. Press READ, then rotate the variable potentiometer.
- 19 Press CHECK. This applies the internal reference signal (10MHz) to the logic circuits.
- 20 This display shows the 10MHz signal with a resolution that varies as the measuring time is changed with the potentiometer.

- 21 Set the potentiometer to the lowest possible measuring time and observe the display.
- 22 Press MINIMUM/SINGLE the resolution becomes worse, because the measuring time is now only 1 μ s (6652) or 2 μ s (6654). Note that the MINIMUM/SINGLE measuring time cannot be shown on the display (the time that appears when READ is pressed with MINIMUM/SINGLE on is the display time from the potentiometer).

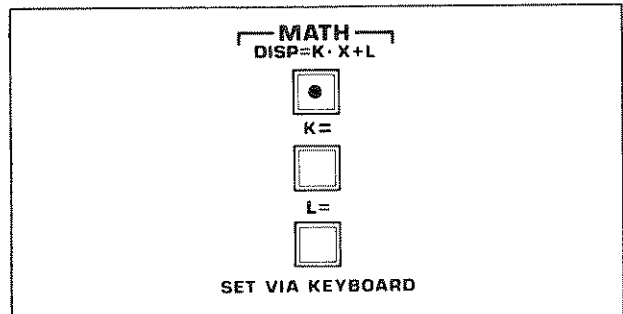

- 23 Set MINIMUM/SINGLE off, and move to the MATH controls. Press DISP= K x X + L. The display should be exactly as before (no change in value).
- 24 Make the function FREQ A.
- 25 Press K=, then enter some value on the key panel. When ENTER is pressed, the displayed result will be changed by the K multiplier. Set an L (addition) value, and change K to an exponential value.
- 26 Setting an exponent is the same as on a calculator: enter the base value, press EE, then enter the exponent. Press ENTER to finish the entry.
- 27 Note that whenever the power was switched off and on again, any values entered are lost, and any controls, other than AC coupling and AUTO go out. If the operator has set up a complicated panel configuration and there is a line failure, all those controls and values will have to be set up again. This is one good reason for the use of the function "Stored Panel Programs".

28 Set up a control panel configuration. Enter some keyboard trigger levels with AUTO on - it isn't necessary to have KEYBOARD on to do this, but the effect is slightly different, as will be seen.

29 Decide if this is a set-up that is to be kept more or less permanently, then press STORE.

30 The program cursor is indicating P1. As a sort of "common sense" operating procedure, it is best to reserve P1 as "work area", in which "temporary" panel layouts are stored so that a line failure doesn't lose a complicated layout. Press STORE to store the configuration in P1, or, before pressing STORE:

31 Select some other P number with the DOWN control, then press STORE. The stored panel program for this panel configuration is now Pn, where "n" is the program number chosen.

32 Switch off then on, and find the program. It isn't necessary to find it if it was still active at power off - it comes back automatically. Check the controls and values stored.

33 Note that the trigger levels set in the program via the key panel have not been selected - AUTO has (check the trigger levels in use with READ. To use the keyboard trigger levels, KEYBOARD must be pressed to override the AUTO levels. If KEYBOARD was wanted in the program as the primary option, then the KEYBOARD button should have been selected when the program was created.

34 Note that though a HOLD OFF "ON" state can be selected and stored, the HOLD OFF time cannot be stored. Nor can the potentiometer trigger level values. Also note that MATH constants cannot be stored in P7 and P8. Try it.

35 Now move the cursor out of the program indicators and select FREQ A with no program indicator. Note that the controls and values of the controls remain as they were set in the last program selected. That is, the last P-number at which the cursor was stationary. If the cursor "scrolls" continuously through P1...P8, no program is selected. To get back to the "initial" state, switch the power off, then on.

36 Because the potentiometer settings for trigger level and HOLD OFF cannot be stored, and if these are the controls selected in a program (AUTO and KEYBOARD off, HOLD OFF on), then the microcomputer will accept the values currently set on the potentiometers.

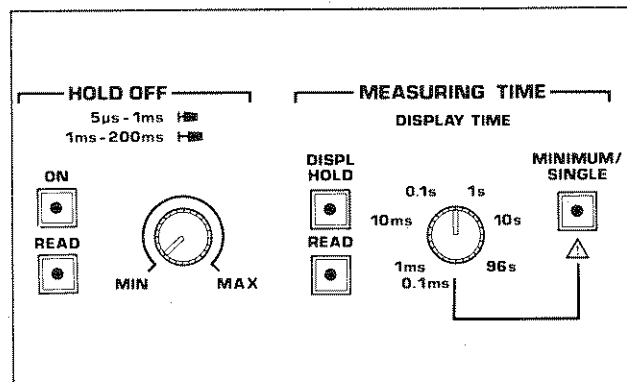

37 Select the program created earlier and then note the measuring time. Switch the power off, rotate the measuring time potentiometer as far as it will go in one direction, then switch on again. Check the measuring time with READ. It is that stored in the program, not that on the potentiometer. So if a new program is created, that measuring time on the display will be put into the new program.

38 Rotate the measuring time potentiometer. The program measuring time is overridden, and any new program created now will accept the new measuring time. The old measuring time is, of course, still in the "old" program. Try this.

39 Make a program with the rear panel switch ARMING/AVG/EXT GATE in any position but OFF. The state of the switch will show on the display panel. Turn the power off and set the rear panel switch to OFF. Power on and try to store the program without the switch function.

40 No matter how many times STORE is pressed, the ARMED or AVG or EXT GATE function persists in remaining in the program. To get rid of it, move the switch up and down, and then leave it OFF. This time, the indicator has gone.

41 Now connect an input signal and start measuring.

CONTROL PANEL LOGIC

The front panels of the PM 6652 and 6654 are arranged with a certain common logic to the way in which the keys and indicators operate. These common factors are:

Colour Coding

The descriptive text around the front panel keys is colour coded. The meaning of the colours is:

- ORANGE - The control is one used to set or store a numerical value (i.e., trigger level or mathematical constant).
- GREEN - The control is in the state expressed by the green script when the LED is alight. When the LED is not lit, the control is in the state indicated by the white script.
- WHITE - White text is used to show the function of a group of controls, and to indicate the function of a control which has only one operational state (e.g., the READ controls).

LED Indicators

The LED indicators are colour coded to show:

- GREEN - The green script state applies.
- STEADY RED - The control is active (e.g., READ). No measurement is possible.
- BLINKING RED - Applies to the ENTER key when it is expected that either the ENTER key or RESET (to cancel the condition) should be pressed next.

Using LOCAL/RESET*

A short depression of the LOCAL/RESET button makes the counter switch from remote to local mode.

If the button is depressed longer than 400 ms, it also activates the RESET function.

RESET stops the measurement and resets the display to zero when depressed. It also cancels READ, ENTER and STORE. When released a new measurement is started. Although certain other controls will also do this, it is good practice to use RESET.

RESET interrupts measurement for as long as the RESET control is kept pressed. It will not destroy values entered as trigger levels via the KEYBOARD function, or MATH constants.

- * The button is only a RESET button on the PM 6652, 54. Switching to local can only be performed from the IEEE-488 bus.

DESCRIPTION OF CONTROLS

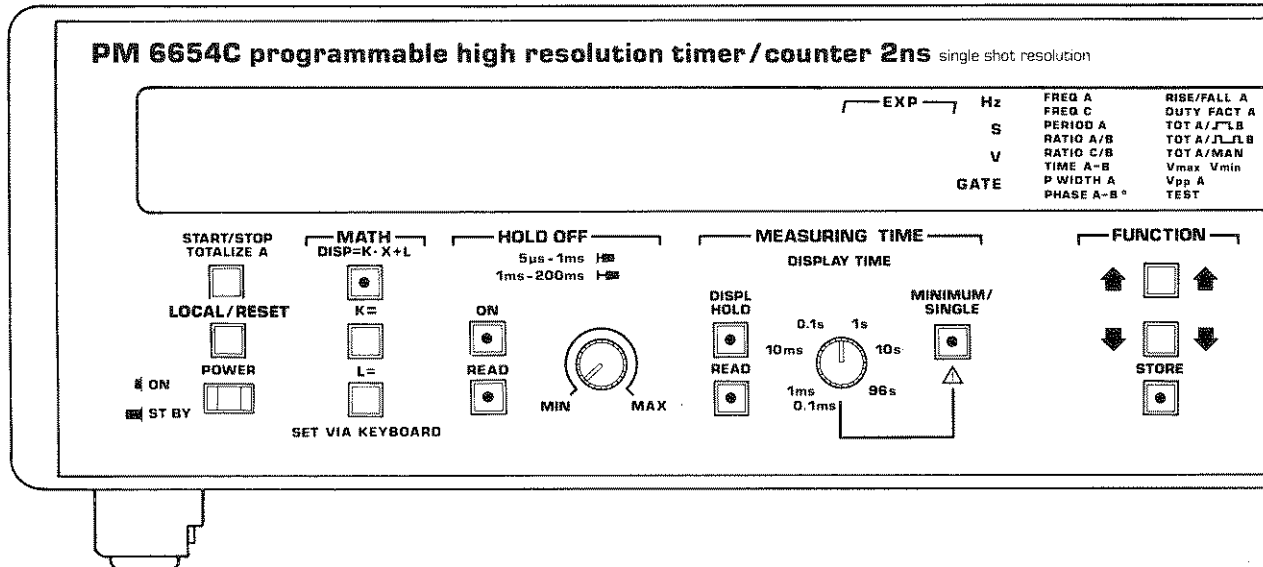

The following is a brief description of the various controls and "control groups" on the PM 6652-54 front and rear panels. Information on the way in which the controls are applied to measurement is given in the chapter "Practical Measurement".

POWER ON/ST BY

Note: this is a secondary power switch, in the out (ST BY) position, power is supplied only to the oven stabilising circuit (when an oven stabilised oscillator is fitted). See "Installation" for a description of the power on self test.

LOCAL/RESET*

A short depression of the LOCAL/RESET button makes the counter switch from remote to local mode. If the button is depressed longer than 400 ms, it also activates the RESET function.

RESET interrupts measurement, clears the display and certain control states. Will not cancel pre-set trigger or mathematical values.

* The button is only a RESET button on the PM 6652, 54. Switching to local can only be performed from the IEEE-488 bus.

START/STOP TOTALIZE A

Used when the function is TOT A/MAN, this control starts and stops the "event counting".

MAThematical constants

K and L are mathematical constants supplied by the user, and used in the formula $DISP=KxX+L$ when the $DISP=KxX+L$ key is selected (LED on).

The measured result will be modified by K and L before displayed. K and L are set by pressing K= and/or L=, entering the value on the key panel, then pressing ENTER. Any further depression of K= or L= will show the last values entered, and will set the ENTER light on. RESET will cancel the ENTER, but will not change the previous values of K and L.

Unless stored in a stored panel program, any values set for K and L will revert to 1 and 0 respectively when power is switched to ST BY.

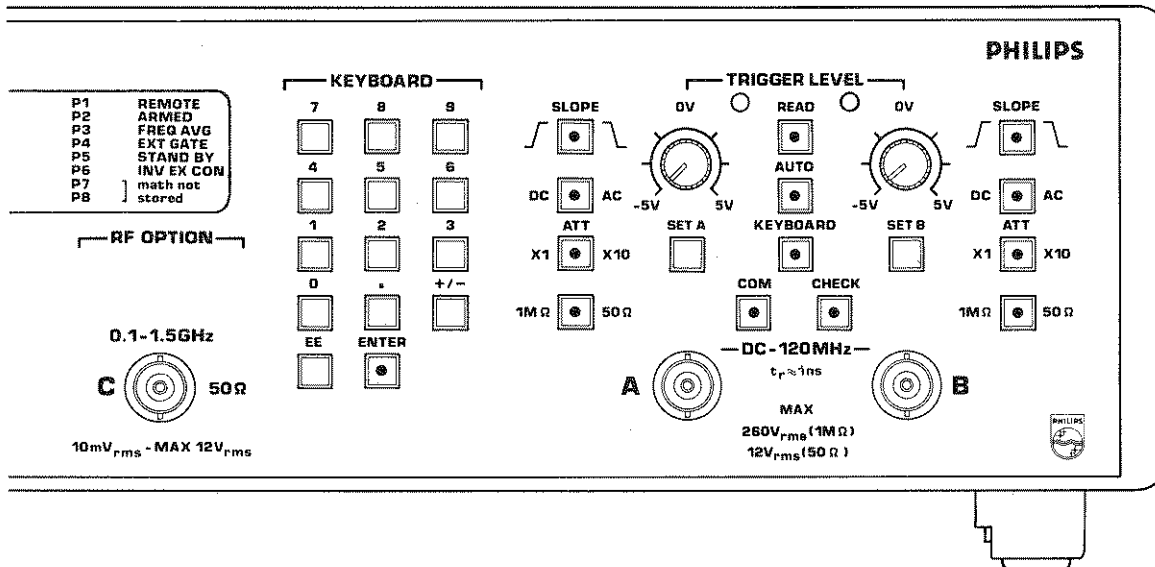

HOLD OFF

HOLD OFF is a feature which gives the user the opportunity of delaying the retriggering to avoid false counts (as from relay bounce). The hold off time is set when HOLD OFF is on (the ON LED is alight) and by adjusting the potentiometer. With the potentiometer pushed, the adjustment range is 5 μ s to 1ms; pulled out from 1ms to 200ms. The value of HOLD OFF is displayed by pressing READ. NOTE that HOLD OFF value cannot be stored. A similar bus programmable function, the Time Interval Delay, is available on the PM 6654C, see Chapter 5.

MEASURING TIME/DISPLAY TIME

The measuring time for continuous measurement is set on the variable potentiometer, which has a range of 0.1ms to 96s. To make measurements on signals having a short duration; MINIMUM/SINGLE is used, giving a measuring time of one cycle or 1 microsecond (PM 6652) or 2 microseconds (PM 6654), whichever is the longer. With MINIMUM/SINGLE selected, the potentiometer becomes a display time control. In this case the display will show a measured result for the time set on the potentiometer. It changes to the latest measured result only after the set measuring (i.e. display) time has expired.

When DISPL HOLD is switched on, the counter completes the measurement in process, "freezes" the result on the display and stops measuring. Single measurements can thereafter be made by pressing the RESET button. The counter will not start continuous measurements again until DISPL HOLD is switched off.

If DISPL HOLD is pressed when TOT A/MAN is selected, the counter will freeze the result on the display immediately without stopping the measurement.

The currently set measuring time is displayed with READ.

Note that after a power down the counter will use the measuring time set by the potentiometer unless a stored panel program P1...P8 is selected.

Measuring time can be stored in a stored panel program.

FUNCTION

The "UP" and "DOWN" push buttons control the movement of the function and program cursors on the display panel. Continuous pressure causes the cursor to "scroll", though the function cursor will hesitate at FREQ A and TEST. Once past FREQ A (going up), or TEST (going down), the program cursor appears. When any stored panel program cursor is lit and the push button released,

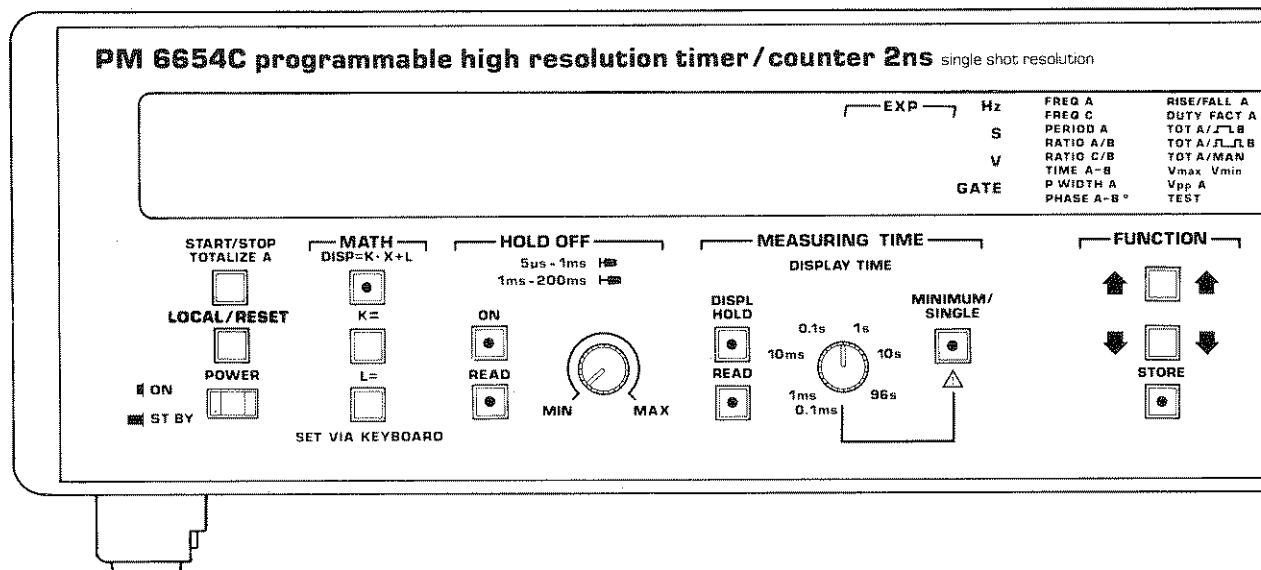

the function cursor takes the position of the function specified in the program. Further depressions of the UP and DOWN controls will now move the program (P1...P8) cursor, with the function cursor respond to successive programs.

If the "INPUT C" option is not installed in the instrument, the function cursor skips over any function containing C reference. STORE is described in "Stored Panel Programs", and the individual functions are covered in "Practical Measurements".

RF OPTION input C

This is an optional input, allowing signals of up to 1.5GHz to be measured.

KEYBOARD

The keyboard is used to enter numerical values (K and L constants and KEYBOARD trigger levels). Exponential values can be entered. The ENTER LED lights automatically after K=, L=, SET A or SET B has been pressed. The LED begins blinking as soon as any keyboard entry has been made. If the ENTER LED is not either steady or blinking, no keyboard entry can be made. The ENTER "ON" state can be cancelled by pressing RESET.

SLOPE

Selects the triggering slope.

DC/AC

Selection of DC or AC coupling of the signal applied to input A and B respectively. Unless a stored panel program has determined otherwise, AC coupling is automatically selected by the microprocessor at switch on.

ATT x1/x10

When the LED is alight, the input signal is attenuated by a factor of ten, and the trigger levels are multiplied by ten.

1M0hm/50 Ohm

Determines the input impedance of input A and B. When the LED is lit, input impedance is 50 Ohm.

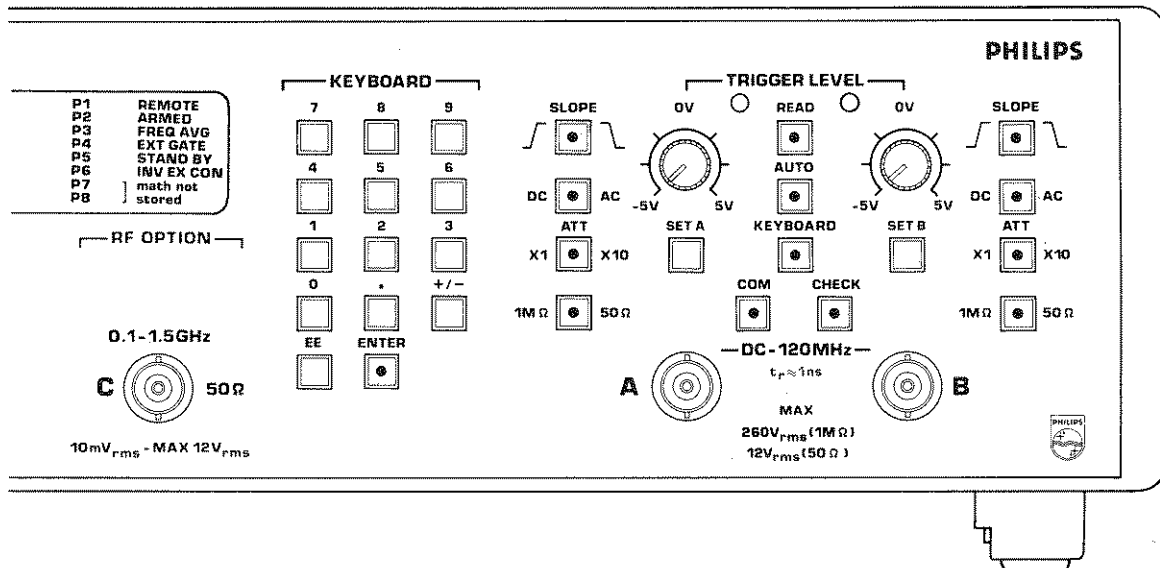

TRIGGER LEVEL

The trigger level is set in one of three ways:

- In AUTO mode the counter automatically calculates the 50% level of the input signal, or sets trigger levels at 10% and 90% of the signal's amplitude. AUTO is automatically selected immediately after power on unless a program dictates otherwise.
- Via KEYBOARD the trigger levels may be set either from a stored panel program or manually from the keyboard.
- Via the potentiometers (both AUTO and KEYBOARD are off). Potentiometer values cannot be stored in a stored panel program.

Trigger LEDs

The trigger level is adjustable between +5V and -5V, or between +50V and -50V (ATT x10). The LEDs show the state of triggering:

- ON - the signal is above the trigger level.

- OFF - the signal is below the trigger level.

- BLINKING - the signal is crossing the hysteresis band.

READ

Shows the current trigger levels. Channel A on the left hand side and channel B on the right hand side of the display.

COMmon

Connects channels A and B internally and disables the channel B connector and impedance (1 MΩ/50 Ω) control. The coupling, attenuation, slope and trigger level controls for channel B remain active.

CHECK

When active, the internal 10MHz reference signal is connected to the logic circuits. CHECK allows a self test of all functions except phase, duty factor, V_{max} , V_{min} and V_{pp} .

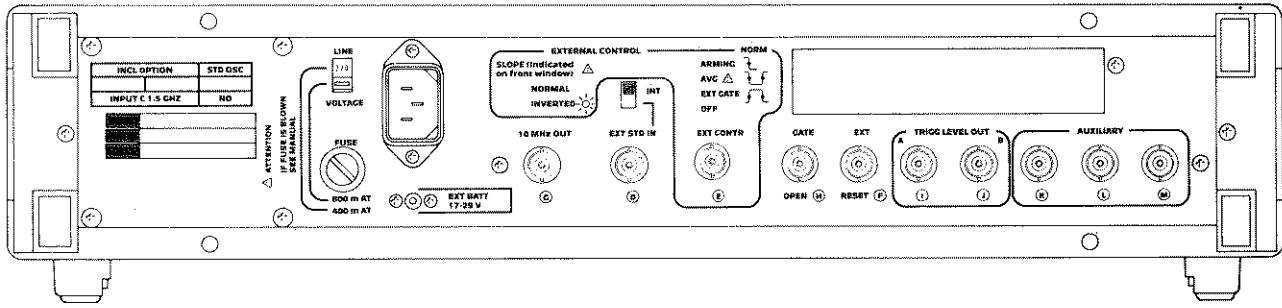

REAR PANEL CONTROLS and CONNECTORS

LINE VOLTAGE SELECTOR

Sets the line voltage for 230VAC (down) or 115VAC (up). SEE FUSE !

FUSE

Ratings: 0.4A for 230VAC; 0.8A for 115VAC. If the fuse blows, check that the fault has been cleared before replacing the fuse. Ensure that the correct rating of fuse is used.

Cursor Control

Allows an electrical remote input to perform the cursor control function.

10MHz OUT - Output G

An output for the 10MHz reference signal.

EXT STD IN - Input D

Allows the use of an external reference signal. Set the switch to the EXT STD IN position.

ARMING/FREQ AVG/EXT GATE/OFF - Input E

Allows the measuring of the input signal to be controlled by an external source. See "Practical Measurements" for the applications. Any switch position but off is indicated on the display.

SLOPE*

The setting makes Input E is active high (NORMAL) or active low (INVERTED). The setting is indicated on the front panel display.

* This function is not available on PM 6652,-54.

GATE OPEN - Output H

A monitor output to allow observation of the measured time interval and the trigger hold off time.

EXT RESET - Input F

An external electrical reset, equivalent to the front panel RESET control.

TRIGG LEVEL OUT (A, B) - OUTPUTS I, J

Allows the trigger levels on channels A and B to be observed on an oscilloscope. Note that input attenuation of the signals is disregarded, and that the output trigger level range is limited to +5V...-5V.

AUXILIARY Inputs K, L, M (Optional)

These optional inputs replace the corresponding front panel inputs A, B and C. They are factory mounted on request (option PM 9611).

PRACTICAL MEASUREMENTS

CONTENTS	Page
Introduction	4-2
Measuring functions	4-2
Stored panel programs	4-4
Trigger settings	4-5
Mathematics	4-5
Recommended control settings	4-6
Hints and tips	4-8
Time measurements using probes	4-10
What went wrong	4-12

INTRODUCTION

This chapter describes the operation of the PM 6652 and PM 6654 from the viewpoint of its application, and gives practical advice to this end. The principle functions are described, as are the use of stored panel programs and the ancillary facilities. In addition, a few hints and tips and a short "what went wrong" guide are included. A chart, showing recommended control settings for various types of measurements, appears also in this chapter.

Knowledge of the controls, indicators and connectors is assumed (see chapter 3). The use of the IEEE 488 bus is not described (see chapter 5), nor are the operation and results of test programs and other functional checks (see chapter 8).

MEASURING FUNCTIONS

The measuring mode function is selected by using the function control buttons. See chapter 3 and "Stored Panel Programs" in this chapter. For theoretical considerations, see chapter 6.

FREQ A

Sets the instrument to measure the frequency of the signal connected to input A.

FREQ C

Sets the instrument to measure the frequency of the signal at input C. FREQ C cannot be selected if the channel C option, PM 9610 is not fitted.

PERIOD A

Sets the counter to measure the period duration of the signal connected to input A.

RATIO A/B

Sets the instrument to measure the frequency ratio between the signals connected to inputs A and B, with B as the reference signal.

RATIO C/B

Sets the instrument to measure the frequency ratio between the signals connected to channels C and B, with channel B as the reference. Ratio C/B cannot be selected if the channel C option PM 9610 is not fitted.

TIME A - B

Sets the instrument to measure the time interval between events on channels A and B.

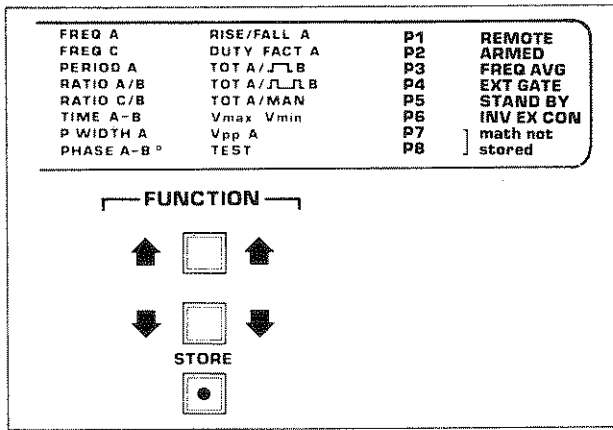

Fig. 4.1 Measuring functions.

P WIDTH A

Sets the counter to measure the pulse width of the signal connected to input A.

PHASE A - B

Sets the counter to measure the phase (in degrees) between the signals connected to inputs A and B.

RISE/FALL A

Sets the instrument to measure the rise or fall time of the signal connected to input A. It is recommended to use auto triggering to get the trigger levels correctly set at 10 and 90%.

DUTY FACTOR A

Sets the counter to measure the duty factor of the signal connected to input A.

TOT A/□LB

The counter will totalize events (pulses or cycles) on input A between the leading and trailing edges of the input B signal.

TOT A/□LB

Sets the counter to totalize events on input A between start and stop events on input B.

TOT A/MAN

Sets the instrument to measure events on input A between depressions of the START/STOP TOTALIZE A button.

V_{max} V_{min}

Sets the counter to measure the positive peak level and the negative peak level of the input voltage on input A.

V_{pp} A

Sets the counter to measure the peak to peak voltage of the signal on input A.

TEST

See "Performance Check", chapter 8.

P1...P8

See "An Introduction To Operating the PM 6652 and PM 6654" in chapter 3 and "Stored Panel Programs", in this chapter.

STORED PANEL PROGRAMS

Introduction

Stored panel programs are of great assistance to those users who have repetitive tasks to perform, and/or if the measurements require complicated control configurations.

A stored panel program is stored in a non-volatile memory with a retention life of at least ten years. Eight programs can be stored, and they are identified by the titles P1...P8. Each of them can contain a full panel set-up and set values, with the following exceptions:

- READ, ENTER, and STORE cannot be set "ON".
- The potentiometer trigger level values cannot be stored but potentiometer triggering can be selected by specifying AUTO and KEYBOARD "OFF".
- No HOLD OFF value can be stored. But HOLD OFF "ON" can be specified.
- No external reference signal can be specified.
- In P7 and P8 only, neither MATH on nor mathematical constants can be stored.

Stored panel programs can be initiated and created over the IEEE 488 bus.

Creating stored panel programs

To create a stored panel program first set all the controls and values (KEYBOARD trigger levels, measuring time and the K and L MATH constants as required). Select the function, then press STORE once. The P1 indicator will be lit. Step the cursor down to the desired program number, then press STORE again. Any program that previously existed in that area will be overwritten completely.

NOTE: It is recommended that P1 is used as a "work area", rather than as a permanently stored program. This means that when there is a complex, temporary set up in use, it can be stored in P1. Any accidental power off or line failure will not, then, destroy the set up.

Overriding stored panel programs

When a stored panel program is recalled, all the controls, indicators and values will be set exactly as they were when the program was created (except as specified in the introduction). The program controls and values can be overridden temporarily by setting other controls and values. This "real time" selection will last as long as the power remains on, or until the program is reselected. Exceptions to this rule are:

- ARMING/AVG/EXT GATE/OFF and SLOPE. If any of these facilities was chosen when the program was created, that facility will appear as the default when the program is reselected whatever the current position of the switch. Moving the switch while the program is active will give the ARMING/AVG/EXT GATE facility which is displayed on the front panel.
- Measuring time. The measuring time set by the program when the program is reselected is that which was set when the program was created, whatever the current position of the measuring time potentiometer. An override measuring time can be set by rotating the potentiometer. Note that to guard against inadvertent movement of the potentiometer, a movement of 1 decade of the potentiometer is required. Once these limits are exceeded, the potentiometer assumes its full analogue range.

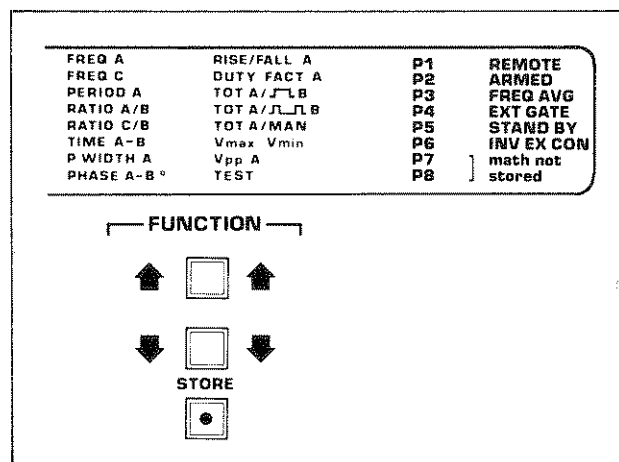

Fig. 4.2 Stored panel programs.

TRIGGER SETTINGS

The PM 6652/54 offers a variety of trigger possibilities, such as trigger slope, input impedance, AC/DC coupling and two trigger level ranges -5...+5V and -50...+50V.

As further described in the chapter "Measurement Theory", always try to set the controls to AC coupling and x10 attenuation for frequency measurements and DC coupling with no attenuation for time measurements.

For many measurements it is vital to have a good impedance matching to avoid reflections which might make the trigger level setting very difficult. Always use the 50 Ohm termination in 50 Ohm systems.

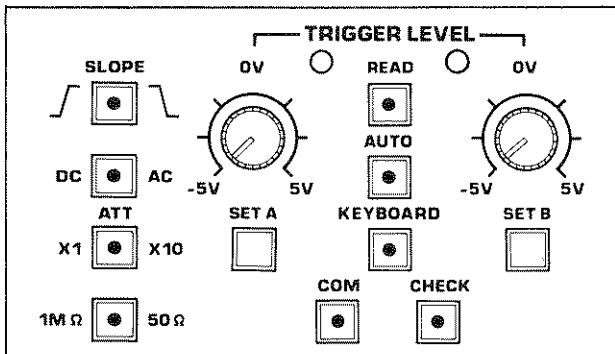

Fig 4.3 Trigger controls.

Trigger level setting

The trigger level can be set in one of three ways: Auto, keyboard or potentiometers.

- In AUTO mode the counter automatically calculates and sets the triggering to the 50% level of the input signal, or for rise/fall time measurements at 10% and 90% of the signal's amplitude. AUTO is automatically selected immediately after power on unless a program dictates otherwise.
- When KEYBOARD is selected, the trigger levels could be entered automatically from a stored panel program, or manually via the keyboard. When the trigger levels are set via keyboard it is good practise to store the values in one of the program positions.

- Potentiometers are selected when neither AUTO nor KEYBOARD pushbuttons are depressed. Note that potentiometer values cannot be stored in a stored panel program.

When the trigger controls have been set, the functioning of the trigger circuits can easily be checked on the trigger indicators, one for each channel. The LED:s show the state of the triggering:

- ON the signal is above the trigger level.
- OFF the signal is below the trigger level.
- BLINKING the signal is crossing the hysteresis band (correct triggering).

MATHEMATICS

On many occasions it is convenient to modify the measured result before presentation in order to make it easier understood. Some examples: An odd result from a transducer can be changed to rpm, or a frequency that has to be monitored may be subtracted before displayed, and the display will only show the deviation.

The formula: $Display = K \times measured\ value + L$ is used when the DISP=KxX+L is selected (LED on). In the formula K and L are set by the user.

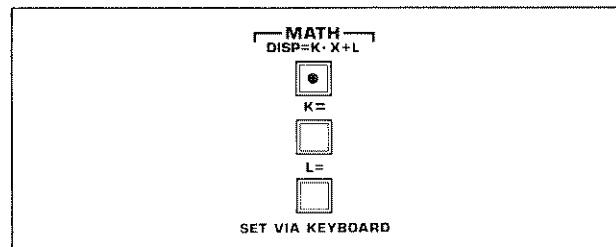

Fig. 4.4 Mathematical controls.

K and L are set by pressing K= and/or L=, entering the value on the key panel, then pressing ENTER. Any further depression of K= or L= will show the last values entered, and will set the ENTER light on. RESET will cancel the ENTER, but will not change the previous values of K and L.

Unless stored in a stored panel program, any values set for K and L will revert to 1 and 0 respectively when power is switched to ST BY.

Repetitive events

Input signal characteristics/ application		Triggering			Input control				External control			Notes		
		Minimum/single	Auto	Keyboard	Potentiometer	Coupling	Slope	Attenuation	Impedance	Hold off	Arming		Frequency average	External gate
Frequency measurements	Normal setting		●			AC	+	x1	1MΩ		○			
	Noisy signal, 100 Hz to 150 kHz		●			AC					●		PM 6654 performance becomes the same as PM 6652	
	Noisy signal, ≤120 MHz			●	○	AC		x10					Only if input signal ≥200 mV _{RMS}	
	Noisy leading edge, ≤200 kHz				○	DC		x1 or x10			●		PM 6654 performance becomes the same as PM 6652	
	Multiple burst frequencies	○		●	○	DC		x1 or x10				●	Must be gated by an external signal	
	Pulse signal, duty factor <0.25 >0.75		●			DC					○			
	Frequency <100 Hz			●	○	DC								
	Fast measurement	●		●	○									Set minimum display time
Period averaging (A)		●			AC					○	○			
Ratio A/B averaging		●			AC									
Ratio C/B averaging					AC									
Time A - B averaging			●		DC		+ or -	x1 or x10		○	○	○		
Time A - B, pulse width A; Start/stop with contact bounces			●	○	DC		+ or -	x1 or x10		●				
Pulse width averaging (A)		●			DC		+ or -			○	○	○	Set pos. slope for pulse width and neg. slope for pulse spacing	
Phase A - B			●		AC		+	x1 or x10					Trig. level=0.00 V. Attenuate if needed to get equal amplitudes for A,B	
Rise/fall time averaging (A)		●			DC		+ or -				○	○	Pos. slope for rise and neg. slope for fall time	
Duty factor (A)		●			DC		+							
Total A/∩ B and total A/∩∩ B				○	DC		+(B)	x1 or x10			○		Pos. slope in channel B	
Totalize A, manually controlled				○	DC			x1 or x10						

RECOMMENDED CONTROL SETTINGS

Single events

Input signal characteristics/ application	Minimum/single	Triggering			Input control				External control			Notes	
		Auto	Keyboard	Potentiometer	Coupling	Slope	Attenuation	Impedance	Hold off	Arming	Frequency average		External gate
Single burst frequencies			<input checked="" type="radio"/>	<input type="radio"/>	DC		x1 or x10			<input type="radio"/>		<input type="radio"/>	Must be gated by an external signal
Single period (A)	<input checked="" type="radio"/>		<input checked="" type="radio"/>	<input type="radio"/>	DC		x1 or x10						
Single ratio A/B	<input checked="" type="radio"/>		<input checked="" type="radio"/>	<input type="radio"/>	DC		x1 or x10						
Single ratio C/B	<input checked="" type="radio"/>		<input checked="" type="radio"/>	<input type="radio"/>	DC		x1 or x10						
Single time A-B	<input checked="" type="radio"/>		<input checked="" type="radio"/>	<input type="radio"/>	DC	+ or -	x1 or x10			<input type="radio"/>			
Single pulse width (A)	<input checked="" type="radio"/>		<input checked="" type="radio"/>	<input type="radio"/>	DC	+ or -	x1 or x10			<input type="radio"/>			Pos. slope for pulse width neg. slope for pulse spacing
Time A-B, pulse width A; Start/stop with contact bounces			<input checked="" type="radio"/>	<input type="radio"/>	DC	+ or -	x1 or x10		<input checked="" type="radio"/>				
Single rise/fall time (A)	<input checked="" type="radio"/>		<input checked="" type="radio"/>	<input type="radio"/>	DC	+ or -	x1 or x10			<input type="radio"/>			Pos. slope for rise time and neg. slope for fall time
V_{max} V_{min} A and V_{pp} A					DC								

Please note that these are recommended control settings for a limited variety of applications. For other tasks (or even those described), the user may find a combination of controls which suits him better. The symbols mean:

This control setting is recommended for the application.



This control may be used as an alternative to another control in the same group, or a control may be used if the operator wishes.

HINTS AND TIPS

This section gives a few hints and tips about practical procedures in operating the counter/timers.

Measuring Time

- Low frequency signals (below 100Hz) will tend to give unexpectedly long measuring times.
- The measuring time control for channel C measurements works in exactly the same way as it does for channel A.
- The measuring time potentiometer becomes a display time control in MINIMUM/SINGLE.
- For FREQ A, FREQ C, PHASE A-B and DUTY FACTOR A, MINIMUM/SINGLE forces the counter to make 1 μ s (PM 6652) or 2 μ s (PM 6654) measurements of the repetitive signal.
- For PERIOD A, RATIO A/B, RATIO C/B, TIME A-B, P WIDTH A and RISE/FALL TIME A, MINIMUM/SINGLE forces the counter to measure a single complete cycle of the input signal (on B, in the case of RATIO A/B and RATIO C/B, but see below).
- For RATIO A/B and RATIO C/B, the use of MINIMUM/SINGLE in conjunction with a start/stop signal on B changes the functions to:

TOT A  B and TOT C  B respectively.

- MINIMUM/SINGLE has no effect in the functions: TOT A/MAN, Vmax, Vmin and Vpp.

Triggering

- The AUTO trigger function will always try to find the 50% level on signals, and will attempt to offset for any DC component. If the counter fails to trigger, because the AUTO triggering feature cannot set trigger levels, the Vmax Vmin function can be used to find the signal's peak values. New trigger levels can then be set via the keyboard, or established on the potentiometers. Similarly, values found by using the potentiometers can be examined and set as KEYBOARD levels.
- A low frequency signal (below 100Hz) will cause problems for the AUTO feature. The trigger levels can be set as described above.

- If a signal contains heavy "spikes", the AUTO feature will calculate a false Vpp. The trigger levels should be set manually.
- KEYBOARD or potentiometer trigger levelsetting is generally recommended for:

Noisy signals < 120MHz
Burst frequencies
TIME A-B averaging
PHASE A-B
Single RISE/FALL TIME A
Single RATIO A/B
Single RATIO C/B
Single TIME A-B
Single P WIDTH A

Coupling

DC coupling is recommended for:

- Burst frequencies
- Single RATIO A/B
- Single RATIO C/B
- Single TIME A-B
- Single RISE/FALL TIME A
- ATE

Attenuation

The ATT x1 x10 control is disabled when AUTO is in use, since AUTO selects the attenuation itself. The LED on the ATT control does not necessarily show the attenuation in use.

In voltage measurements (Vmax Vmin and Vpp), the setting of the attenuator is ignored, giving the true voltage at the input.

Use of x10 attenuation is recommended for noisy signals, if possible.

Impedance

- When performing RISE/FALL TIME measurements, it is important that the waveforms are as clean as possible. Input impedances must, therefore, be matched closely.
- The setting of the impedance control will, of course, affect voltage measurements.

The MATHematics Function

The MATH function can be used to store constants and offset factors which will modify the displayed result. The example used so far has been the case in which a voltage signal (V_{pp}) from a transducer could be converted to a value of volume or other units. Another case in which MATH could be used is to store a factor which compensated for differing delays between channels.

The HOLD OFF Function

The HOLD OFF function is used to avoid superimposed or leading edge noise on input signals. When used, however, the PM 6654's performance becomes identical with that of the PM 6652 (see chapter 9). Applications for HOLD OFF are:

- Superimposed noise on carrier frequencies in the range 5 Hz...150 kHz can be suppressed.
- Leading edge noise can be suppressed on signals in the frequency range 5 Hz to 150 kHz.

HOLD OFF is disabled in the functions PHASE A-B and DUTY FACTOR A. It should not be used in the function RISE/FALL TIME A.

HOLD OFF cannot be applied to any function involving Channel C.

PHASE Measurements

The limiting voltages for PHASE measurements are:

- 100 mV_{RMS} to 3.5 V_{RMS} or
- 1 V_{RMS} to 35 V_{RMS} (x10 attenuation)

A higher input voltage will cause waveform distortion, while lower voltages will result in inaccuracy. Maximum frequency is 2 MHz.

DUTY FACTOR Measurements

The highest frequency at which DUTY FACTOR can be used is 2 MHz.

Voltage Measurements

Accurate voltage measurement is possible up to 20 MHz. Frequencies between 20 and 80 MHz can also be measured but with reduced accuracy.

External Control - INT/EXT STD IN

When the INT/EXT STD IN switch is in the down position, the counter will expect an external standard reference signal. Rules applicable to the use of such a signal are:

- If there is no external signal, the counter will display error E4 after the power on sequence (see chapter 8 "Performance Check"). If the E4 error is RESET and there is still no signal, either:

- The PM 6652 will not measure.

- The PM 6654 will attempt to measure frequencies and single time intervals, but the results will be inaccurate.

When using an external signal for time interval averaging measurements, the standard reference signal should not be synchronised with the input signal.

The INT/EXT STD IN control cannot be stored as a stored panel program parameter.

ARMING/FREQ AVG/EXT GATE/OFF

When this control is in the EXT GATE position, the counter will expect an external control signal, and will not measure until such a signal is supplied. If it is set to ARMING or FREQ AVG, the counter will measure when the control signal is absent, or TTL-low.

When stored in a stored panel program, the external control state can be overridden by switching to a new position. For normal operation, the switch should be set to OFF. The functions are applicable as follows:

ARMING To all but PHASE, DUTY FACTOR and TOT A/MAN measurements.

AVG To FREQ A, FREQ C and PERIOD A and TIME A-B measurements.

EXT GATE To FREQ A, FREQ C and Period A measurements. Example applications are multiple burst frequencies and masked time intervals. Note that if RF burst are to be measured using FREQ C, the burst should contain at least 32 CW cycles.

SLOPE*

This button inverts the EXT CONTR input making the function selected with the ARMING/AVG/EXT GATE/OFF-switch active on the opposite slope. The selection is indicated on the front panel.

* Not available on the PM 6652,-54.

Channel Considerations

Input B is limited to 10MHz in the RATIO modes.
Input C may accept frequencies as low as (approximately) 80MHz.

TIME MEASUREMENTS USING PROBES

Introduction

It is possible to calibrate the probes for Time/Phase measurements directly with a PM 6652 or PM 6654 Timer/Counter. The compensation procedure requires, besides the counter, a generator capable of delivering a 500 Hz square-wave signal with 20 V_{pp} amplitude.

Why are probes used at all?

- a) Probes are used to reduce the influence of the measuring instrument on the device under test. When measuring in high-impedance systems, an 1 Mohm load (normal counter input) might be too low and a 10 Mohm load (probe) is required.
- b) Probes are sometimes used to reduce high voltage levels. The measured level is divided by 10 using a 10 Mohm/1 Mohm probe.
- c) A probe is easy to hook on to different measuring points in a test object. For this purpose however it is not necessary to use a 10:1 probe. A single wire with a test hook might do as well ("simple 1:1 probe").

Measurement problems

- a) When an over-compensated probe is used in pulse measurements, an "overshoot" is generated in the counters input. This makes the V_{pp} measurement go wrong. The display shows a too high value.

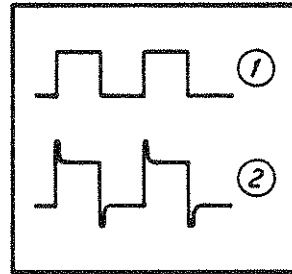
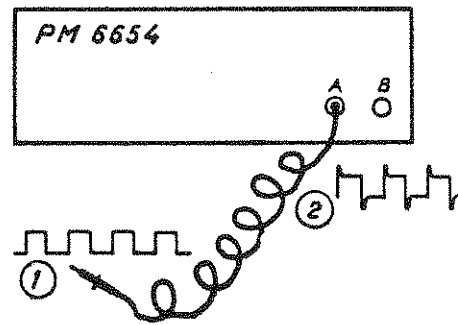

- b) Very short Time Interval measurements might go wrong when two **differently compensated** probes are used. An example is given below:

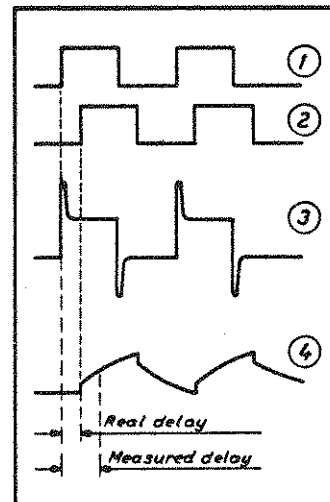
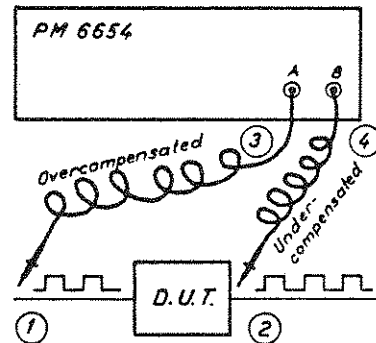

Look-out for the impedance of the counter!

The input impedance of the counter is reduced to from 1 Mohm to 500 kohm when:

- a) COMMON inputs have been selected.
- b) P-WIDTH, RISE/FALL TIME or DUTY FACTOR measurements are selected.

This means that a probe compensated with a 1 Mohm load from the counter is un-compensated in the above cases (500 kohm).

In conclusion, a calibrated probe should **only** be used when separate A and B inputs have been selected otherwise the probe will no longer be compensated.

EXAMPLE: When e.g. rise time should be measured using probes, a Time Interval measurement with separate inputs must be selected. The input signal must **externally** be fed to both inputs via two separate (calibrated) probes. Thus the 'COM'-function should **NOT** be used. The levels must be set manually to 10% (A-channel) and 90% (B-channel) resp.

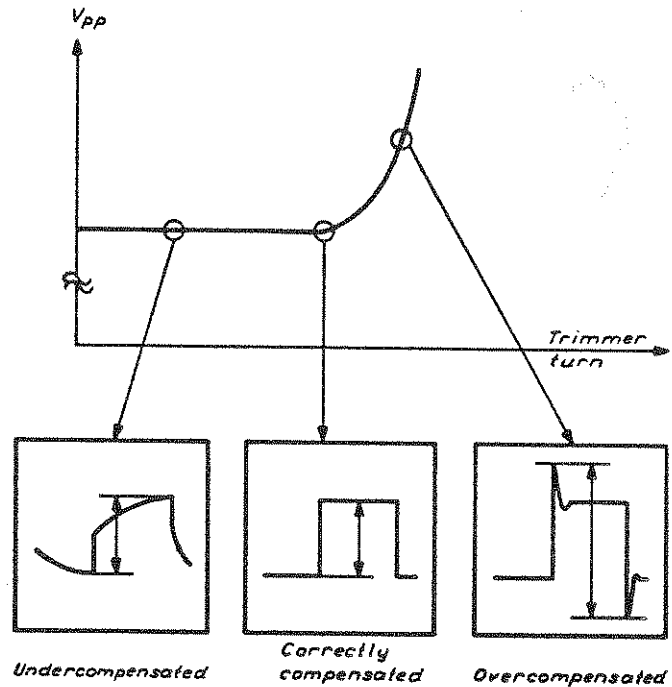

Probe compensation in PM 6652 and PM 6654

- 1) Set counter inputs to ATTx1, 1 Mohm termination and SEPARATE inputs (NOT 'COM').
- 2) Select V_{pp} -function.
- 3) Connect probe to input A.
- 4) Connect a generator, via the probe, and set square wave signal, 500 Hz and 20 V_{pp} .
- 5) Turn Probe trimmer until a stable **minimum** voltage reading is obtained.
- 6) Turn probe trimmer slowly until the voltage reading increases sharply.
- 7) Turn probe trimmer backwards (very slowly) until minimum voltage plus 10 mV is obtained.
- 8) The probe should now be correctly compensated, see the "knee" in the trimmer curve below.

WHAT WENT WRONG?

The PM 6652 and PM 6654 feature a high MTBF figure (more than 20000h) thus ensuring reliable operation. If a measurement failure occurs, the problem will most certainly be one associated with the operation of the instrument. Below is listed some of the possible failure symptoms, assuming that the input signals to be measured are present and connected.

The instrument fails to measure

Symptom: The display shows all zeroes

- First press RESET and try again.
- The counter is not triggering. Check the trigger levels, AC/DC coupling, impedance and attenuation, if necessary, go to KEYBOARD or potentiometer control.
- The input frequency is too high, or the pulses present at the input are too short.
- A very long measuring time has been selected. Adjust the measuring time - or wait.
- The STORE button is lit (i.e., the counter is waiting for a program to be stored). Press STORE or RESET.
- External control is being used, and there is an incorrect signal present on input E.

Symptom: The display is "frozen"

- First activate RESET and try again.
- A long measuring or display time has been selected. Adjust the measuring/display time, or wait.
- DISP HOLD is on.
- EXT GATE is in operation, and the gating signal has become disconnected.

Symptom: The display shows an overflow

- The MATH control is active, with a large exponent value set as K. Disable the MATH feature, or change the K value.
- In PM 6652 frequency measurements, the INT/EXT STD IN has been switched to EXT, and there is no Input D signal.

The measurement is incorrect

Symptom: The measurement is slightly incorrect

- An ERROR E4 has been reset with the INT/EXT STD IN switch in the EXT position. Either switch to INT, or supply an external reference signal. (PM 6654 only, in TIME INTERVAL single mode).
- MATH is on, and there are values other than 1 and 0 in K and L, respectively. Either switch off MATH, or set correct values in K and L.

Symptom: The display showing a more or less constant value

- Either CHECK or COM are on; the latter in cases when a signal on channel B is required for the measurement. Switch (them) off.
- MATH is ON, and there are invalid values (for this measurement) in K and/or L.

Symptom: The measurement varies widely

- HOLD OFF is on, and the time is set to an incorrect value for the measurement. Either switch HOLD OFF off, or adjust its value.
- The signal is very noisy. See the reference chart.

Chapter 5

IEEE-488 BUS INTERFACE

CONTENTS	Page
Introduction	5-2
Interface specifications	5-4
Programming instructions	5-6
Panel mnemonics	5-9
Service request	5-11
Output data	5-12
Status byte	5-14
High speed dump mode	5-18
Program examples	5-20

INTRODUCTION

The PM 6652,-54 timer/counters have been designed for use in automatic test system applications, featuring e.g. 19" cabinet, provision for rear panel inputs and optional fan cooling.

All software needed for the bus operations are included as standard, whereas the optional PM 9696 interface board is the hardware required for connection to the IEEE-488 bus.

PM 6652,-54 timer/counters equipped with a PM 9696 IEEE-488 Bus Interface meet the requirements of IEC-625-1 and IEEE-488 as far as hardware is concerned. They also satisfy the requirements concerning codes and formats according to IEC-625-2 and IEEE-728.

When ordered simultaneously with a counter, the interface is supplied factory installed, but is available as a separate option for field installation. When installed, all front and rear panel functions are remotely accessible via the IEEE-488 bus.

The BUS performance features include:

- Full programmability of all front and rear panel controls (except power on/off Hold Off* time and int/ext reference selector).
- Monitoring of HIGH/LOW limits with SRQ alarm.
- High measuring speed. In normal bus data transfer mode the number of readings is approx 30-50/sec. depending on measuring function (measuring time is Min. or single).
- Computer dump output mode (output of "raw" register data) yields approx. 400...500 readings/sec.
- BUS LEARN mode for quick and easy programming of the counters.
- 8 preprogrammed front-panel menus can be recalled via the IEEE-488 Bus with a single instruction.

The PM 6652,-54 can be programmed in 3 different ways: P1...P8 programming, bus learn mode and normal programming.

*) The PM 6654C has a function called Time Interval Delay, which is similar to the Hold-Off but fully bus programmable. See page 5-10.

P1...P8 programming

The simplest and easiest way is to specify up to eight different measurements and manually set all corresponding controls and store them in locations P1...P8 in the counters.

After that, bus programming is only a matter of selecting one of the 8 possible menus (P1...P8). This is done simply by sending programming code "LP1...LP8" to the counter.

This ultra-simple programming method is suitable for lab cluster applications where different temporary measurements are carried out and where is no time or no need for sophisticated BASIC programming techniques.

A sample program for HP 85 is shown below, where the purpose is to print-out frequency measurements (stored in P3). The controller's address to the counter is 710 (the counter's address selection switch is factory preset at 10).

```
10 OUTPUT 710; "LP3"  
20 ENTER 710; A$  
30 PRINT A$  
40 END
```

With this ultra-simple programming method it is necessary to remember only one single mnemonic (LP).

Bus Learn mode or P9... P∞

"Bus learn" means that the controller copies all manual counter settings and stores the setting in the controller's own memory. The settings are stored as a "counter programming status string" and this string can later be sent to the counter for reprogramming.

The bus learn mode extends the memory locations P1...P8 (in the counter) to P9... P∞ (in the controller).

The procedure for storing e.g. "P9" is:

1. Manually set all counter controls for the desired measurement.

NOTE: The Time Interval Delay* and Voltage measurement on the B input must be selected from the bus, if to be used.

2. Send programming code "P1" (Program data out) to the counter.
3. Enter the programming string (43 ASCII characters) and store in the controllers memory.

The bus programming efforts thereafter are reduced to just recalling the stored string.

A sample program for HP85 is shown below. Ten pulse width measurements should be printed out. The pulse width measurement menu is to be stored in memory location "P9".

```

10 REM STORE MANUAL SETTINGS IN P9
20 DIM P9$(43)
30 OUTPUT 710; "P1"
40 ENTER 710; P9$
.
.
.
200 REM RECALL P9 AND MEASURE
210 OUTPUT 710; P9$
220 FOR N = 1 TO 10
230 ENTER 710; A$
240 PRINT A$
250 NEXT N
.
.
.

```

This programming method is also simple to use. Only one programming code must be remembered (P1)

Normal programming

"Normal" means that the counter settings are specified remotely, not manually as in the previous examples.

The advantage with "P1...P8" or "Bus learn" programming is that it requires a knowledge of very few programming codes (just "LP1...LP8" or "P1"). Thus preparation and programming time is reduced to a minimum. The advantage with "normal" programming is that one can make use of the full programming power and flexibility inherent in the counter's smart software. With "normal" programming service request interrupts, limit monitoring alarms, high speed dump mode, leading zero suppression and much more can be executed.

- The normal programming procedure is:
1. Set counter to default position (FREQ A, AUTO trigger, AC-coupling (A), Meas. time = 0.1s etc.). The code used is "D".
 2. Program the changes from the default settings (e.g. SM2 for 2 seconds measuring time).

A sample program for HP85 is shown below. Ten PHASE A-B measurements (code "F8") with 10ms measuring time (code SM10E-3) should be printed out.

```

10 OUTPUT 710;"DF8SM10E-3"
20 FOR N = 1 TO 10
30 ENTER 710; A$
40 PRINT A$
50 NEXT N
60 END

```

Normal programming should be made when the software must be optimized for its purpose, e.g. in ATE systems.

Note: When the counter has been switched to stand by in programmed mode, it returns when switched on again into local mode after the self test sequence.

Mode	Bus communication time	Setting time	Comments
P1...P8	Short 3 ASCII characters	Long (EARAM involved)	Very simple and fast programming. Limited to 8 measuring tasks.
Bus learn (P9...P∞)	Long 43 ASCII characters	Normal	Easy programming. Number of measuring tasks is limited only by the controller's memory
Normal programming of changes	Short to normal	Short to normal	Flexible and powerful programming

TABLE 5.1 The different programming methods are summarized in the table.

INTERFACE SPECIFICATIONS

For a complete description of the IEEE-488 interface functions, see the Philips instrumentation systems reference manual. As supplied with either a PM 6652 or PM 6654, the PM 9696 has bus capabilities according to table 5.2.

Description	Code	Capability
Source handshake	SH1	Complete
Acceptor handshake	AH1	Complete
Control function	CØ	No controller
Talker function	T5	Complete
Listener function	L4	Complete (except listen only)
Service request	SR1	Complete
Remote/local function	RL1	Complete
Parallel poll	PPØ	No parallel poll
Device clear function	DC1	Complete
Device trig. function	DT1	Complete

Table 5.2 Summary of interface functions.

Interface characteristics

Under the standards established for interface function subsets in IEC 625, many of the functions can have only two states: present or absent. A function which is present is indicated by a "one", and one which is absent by a "zero" after the function code. Examples are SH, AH, SR, DT, (see table 5.2).

Other interface functions can be implemented in different ways. For instance, there are 9 different "talker" functions (T0...T8), and 5 "listener" (L0...L4) possible. In the PM 9696, the talker function T5 and listener function L4 are included.

- The talker function T5:
 - Basic talker.
 - Talk only mode.
 - Serial poll.
 - Automatic unaddressing when addressed as listener.

- The listener function L4:
 - Basic listener.
 - Automatic unaddressing when addressed as a talker.

Source and Acceptor Handshake (SH1, AH1)

SH1 and AH1 simply means that the counters are capable of exchanging data with other instruments or a controller, using the bus handshake lines (DAV, NRFD, NDAC).

Talker Function (T5)

The counter can send its measuring results to other devices or to a controller ("it talks"). T5 also means that the counter can send out a status byte as a response to a serial poll, initiated by the controller.

Listener Function (L4)

The counter is capable of receiving programming instructions from a controller ("it listens").

Service Request (SR1)

The counter can interrupt the controller, e.g. after completion of each measurement, to advise that it has data to send.

Remote/Local (RL1)

The counter can be controlled manually (locally) or remotely, via the bus.

Device clear (DC1)

The counter can be reset remotely and forced to default settings.

Device Trigger (DT1)

Enables remote starting (triggering) of a new measurement via the bus.

Address selection

All devices on an IEEE-488 bus must be assigned a bus device address. The counter address is selectable by the five right-most switches at the rear panel address selector. All addresses except 31 (=11111_{BINARY}) are allowed. At delivery the selected address is 10 (01010_{BINARY}).

Talk only

By setting the leftmost address selector (TALK ONLY) in position 1, the counter will not be addressable. TALK ONLY mode is used when measuring data is to be transmitted directly to a listener without any controller involved. A counter (Talk only) can for example be directly connected to a printer (Listen only) for continuous printing of counter data.

Talk only mode must never be used in bus configurations including a controller. Talk-only mode implies that the counter will no longer "listen" to the controller. If the counter is accidentally switched to Talk-only mode, the bus will be blocked, and no other instrument will be able to "talk" on the bus.

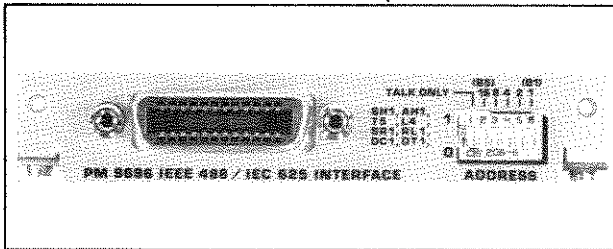

Fig. 5.1 Bus Interface panel.

Timing specifications

Max data output rate

Normal mode: 30...50 readings/sec.
High speed dump mode: Approx. 420 readings/sec.
 V_{max} , V_{min} or V_{pp} : 3...4 readings/sec.
With AUTO-trigger: 3...4 readings/sec.
With mathematics: Approx. 20...25 read./sec.

NOTE: The highest output rate is obtained at minimum measuring time, with MATH and AUTO trigger disabled, no parameters changed between readings, free-run mode and a controller that does not limit the counter output rate.

Output time for measuring data

Normal mode: Approx 5 ms (18 bytes)
High speed dump mode: Approx. 2 ms (24 bytes)
Response time for addressing: Approx 5 μ s
Response time for trigger command (GET);
- Normal mode: 500 μ s
- High speed dump mode: 200 μ s

NOTE: The counter must be programmed for triggered mode and ready for measurement.

Nominal read time for programming data

NOTE: "Read time" = "Bus occupation time"

Single command: 0.5 ms/byte (average)

Multiple commands;

Last command in string: 0.5 ms/byte (average)

Previous commands:

- Measuring modes: 2 ms/byte (average)
- Other input and measuring functions: 0.5 ms/byte (average), except the non-measuring functions, possibly used during system initiation.

- READ Hold-off/Meas. time/trigger levels: 2 ms/byte (average)
- Test 1...6: 8 ms/byte (average)
- Store P1...P8: 240 ms/byte (average)
- Load P1...P8: 20 ms/byte (average)

NOTE: Always use the most time consuming command last.

Electrical specifications

Output connector: IEEE recommended type Amphenol 57 series "Micro ribbon".

Output: E1 (open collector).

Output voltage; High: Above 2.5 V
Low: Below 0.4 V at 48 mA

Input; Hysteresis typ: 0.8 V
High: Above 2.0 V
Low: Below 0.6 V

Termination; (Resistance config.): 3.3 k Ω \pm 5%, to +5 V
6.2 k Ω \pm 5%, to ground

Capacitance: Below 100 pF

PROGRAMMING INSTRUCTIONS

The counter is instructed to perform various measurements when it receives appropriate programming codes (the counter is "listening" to the controller).

The programming code is a string of one or several ASCII characters. The first character is always alphabetic, and the string is terminated by a delimiter sent out from the controller.

Input delimiters

The PM 6652,-54 can accept six different input string delimiters, and will thus recognize programming messages sent from any controller.

LF (Line feed)
CR (Carriage return)
ETX (End of text)
ETB (End of text block)
, (Comma)
; (Semicolon)

Programming code format

The numerical values for measuring time, trigger levels and math constants K and L can be represented in accordance to all three standardized (IEC-625-2) formats NR1, NR2 or NR3.

NR1: Integer value (without decimal point).

NR2: Scaled (with floating decimal point).

NR3: Exponential notation with floating decimal point and exponent. Preferred exponent values are multiples of ± 3 . However, the counter also accepts exponent values other than multiples of ± 3 .

Example: A measuring time of 1.5 s can be represented as SM1.5, SM15 E-1 or SM0.015 E2.

If a programming string contains several functions, for example: Period measurement (code F3), hold-off active (code HE1), measuring time 2 s (code SM2), the different programming codes can be separated by commas (F3,HE1,SM2), by spaces (F3 HE1 SM2) or not separated at all (F3HE1SM2). Spaces can be inserted anywhere in the programming string, e.g. (F 3 HE 1 SM 2).

Programming codes

The programming codes are shown on the next page. Note that frequency A measurements for the PM 6652 can be performed in two different ways:

- Automatic choice of reciprocal mode (below 10 MHz) or conventional mode (above 10 MHz), code F1.
- Always reciprocal mode, code F1G3.

The PM 6654 always uses reciprocal frequency mode.

Measuring V_{max} , V_{min} , V_{pp} on channel B

Channel B voltage measurements are only accessible via the bus, and not via the front panel in local (manual) mode.

The used mnemonics are:

F14QB1 for turning on V_{max} , V_{min} B.

F15QB1 for turning on V_{pp} B.

QBØ for turning off V_{max} , V_{min} or V_{pp} B.

The voltage B - function is an odd feature with some exceptions to "normal" condition.

- QB1/QBØ are never shown in the program data out string. I.e. the controller will never know if channel A or B is selected in volt measurements.
- QB1/QBØ cannot be stored in the front panel menus P1...P8.
- QB1 should be sent after the specified function (F14 or F15). I.e. F14QB1 is ok, but QB1F14 is not.
- Always turn off the selection of volt B by QBØ when the measurement is finished.

Device clear

Sending the string "D" will program the counter to default settings which are:

Frequency A, No external control, Min/single off, Measuring time = 100 ms, Math off, Trigger level Auto, Set keyboard trigger levels A = B = 0 V, Coupling A = AC, Coupling B = DC, Attenuation (A and B) = x1, Trigger slope (A and B) = positive, Termination (A and B) = 1 Mohm, COM via A off, Stop manual gating (TOT A only), Dump mode off, service request disable, hold-off off, check off, triggered mode off and default delimiter setting. See "Delimiter settings".

Sending a single: "D" will thus result in the same counter performance as:

```
"F1GØSSØSM1E-1SK1SLØMEØTL2ALØBLØAC1BCØ  
AAØBAØASØBSØATØBTØCEØTOØHSØSQØHEØCHØTEØ"
```

Sending a "D" is the same as sending bus commands DCL (device clear) or SDC (selective device clear).

Program data out

When PØ or P1 (program data out) is sent, the next output from the counter will not be measuring data but 8 strings (PØ) or 1 string (P1) containing the settings of the counter. The string(s) can be sent back to the counter for later programming. In this way it is possible to perform remote programming of the counter by copying the local settings (BUS LEARN). The procedure is:

- a) Set the counter as desired in local mode.
- b) Output a "PØ" or "P1" to the counter.
- c) Enter the string from the counter (for later use).

Sending a "P1" results in an unreadable 43 character string which should only be used for reprogramming the counter.

Sending a "PØ" returns the programming data of the counter in a readable form, suitable for display on a controller screen or for direct printout. The data is sent as 8 strings each terminated by the selected delimiter.

The format is shown in the table below. The following abbreviations are used:

- ± means + or - sign
- v means either Ø or 1.
- w means digit Ø...2
- x means digit Ø...3
- y means digit Ø...6
- z means digit Ø...9

```
FzzSMzz.E±zSSv  
ACvASvAAvATvAL±z.zz  
BCvBSvBAvBTvBL±z.zz  
TLwTOvCEvCHvTEv  
SQxHSvLEvMSvSDx  
GyHEwMEvRMvRHvRLv  
SK+zzzzzzzz.E±zz  
SL+zzzzzzzz.E±zz
```

NOTE: The decimal point, where present, is fixed. A K value of 60 will be sent as: "SK+00000060.E+00", whereas a L-value of 3750.65 is sent as: "SL+000375065.E-02".

PANEL MNEMONICS FOR BUS-INTERFACE OPERATION

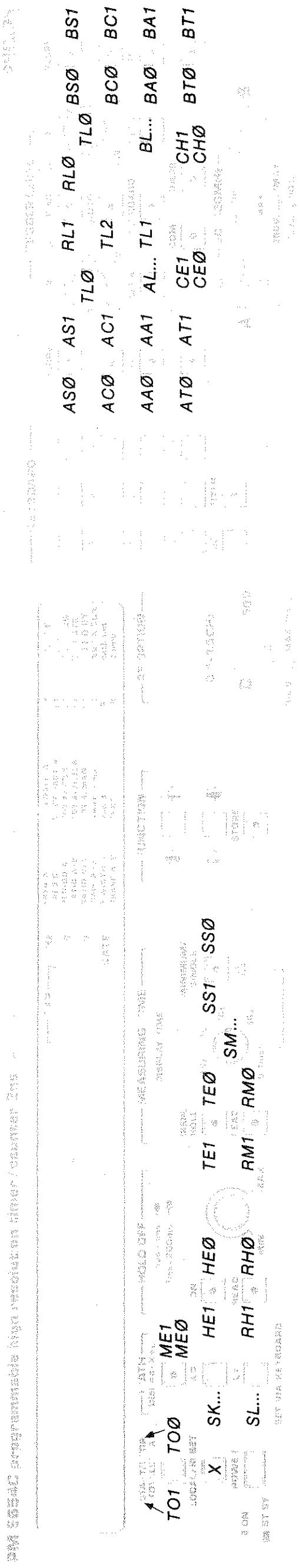

When a single function pushbutton has two mnemonics, the one ending with Ø means the inactive state.
Three dots (...) after a mnemonic means the numerical value.

F1	PHASE A	F9	RISE/FALL A	SP1/LP1	P1	REMI
F2	PHASE B	F10	OUTY FACT A	SP2/LP2	P2	G1
F3	PERIOD A	F11	TOT A/TL	SP3/LP3	P3	G3
F4	RATIO A/B	F12	TOT A/TL	SP4/LP4	P4	G2
F5	RATIO C/B	F13	TST A/MAIN	SP5/LP5	P5	STAND BY
F6	TIME A-B	F14	V _{max} V _{min}	SP6/LP6	P6	INVER COM
F7	WIDTH A	F15	V _{PP} A	SP7/LP7	P7	RING TAP
F8	PHASE A-B	TS1-TS6	TEST	SP8/LP8	P8	STOP

SP. = Store Program
LP. = Load Program



Fig. 5.2 Front panel mnemonics for bus interface operation.

(This picture page is also found on reverse side)

Tests numbers 1...6

6 independent hardware tests (TS1...TS6) can be performed according to the table below.

Test 1 ROM test.	4 Measuring logic test.
2 RAM test.	5 Display test.
3 EAROM test.	6 Tests 1-5 in sequence.

To perform any test, the normal procedure is as follows:

- Enable Service Request (code "SQ1").
- Call e.g. test No. 1 (code "TS1").
- When SRQ is recognized by the controller a serial poll is performed and the status byte is checked to see if the test was satisfactory. The status byte is described in section "Status Byte".

Performing the first step above is optional. To speed up the test procedure, skip the first step and go directly to the second step.

Any running test will be stopped when the controller either reprograms the counter or requests measuring data. In this case the test will have to be restarted if it is to be completed.

Trigger mode

When triggered mode is enabled by sending a "TE1", the counter will perform only one measurement at a time. Every individual measurement must be triggered by either the GET (Group Execute Trigger) bus command or by sending "X" (execute). This allows accurate control of the start of the measurement. When "TE0" is chosen (the default value), the counter is free running, (i.e. as soon as one measurement is finished, the next will start).

NOTE: The counter may perform only one measurement at a time even in the free-running mode. This is the case when the counter is an active talker (e.g. caused by an ENTER-command from HP 85).

Let us consider the	10 OUTPUT 710; "D"
following HP 85	20 ENTER 710; A\$
program example:	30 PRINT A\$
	40 END

In line 10 the counter is set to frequency A measurements (Default) and the measurement is started (TE0 is default).

In line 20 the counter is made an active talker and instructed to handshake the result over to the HP 85. Since the counter is free-running the next measurement starts directly.

In line 30 the first result is printed. By now the second measuring result is ready and displayed, but since the counter is still an active talker it will stop and wait for a handshake procedure to take place.

In line 40 the program ends so this handshake will never take place, and the counter will have to wait for ever.

Now we might find different values on the counter's display and on the HP 85 printer. This is obvious since the printed result is the first measurement and the displayed result is the second.

Time-Interval Delay (Programmable Hold Off)

The PM 6654C (not the PM 6652,-54 nor PM 6652C) is capable of measuring single shot time-intervals using the Time-Interval Delay function, where the delay time can be programmed via the IEEE-488 bus. This function is thus equivalent to the front panel function Hold-Off.

When programming command "HE2" is sent to the counter, the counter rejects stop-pulses for a time equal to the set **Measuring time**. HE0 switches off the function.

The Time-Interval Delay range is 100 μ s...99 s. The accuracy is $\pm 25 \mu$ s ± 1 % of set value.

Applicable functions are:

Time interval A-B, single	("F6SS1")
Single pulse width A	("F7SS1")
Single rise/fall time A	("F9SS1")

Example: Time-Interval Delay programmed for 1.5 ms in a single pulse width measurement: "F7SS1SM1.5E-3HE2"

NOTE: Time-Interval Delay cannot be selected together with Hold Off.

HE2 is accessible via the IEEE-488 bus only and cannot be stored in the front panel menus P1...P8. It is however stored in the bus learn string.

SERVICE REQUEST

A Service Request (SRQ) is sent from the counter to the controller in the following cases:

When service request is disabled (SQ0)

- On programming errors, such as false codes, measuring time out of range, trigger levels out of range etc.
- After the execution of any of the tests TS1... TS6 and a test error is found.

When service request is enabled (SQ1)

- When a measuring result is ready for output.
- Any of the tests TS1...TS6 is finished.

When limit monitoring is enabled (SQ2, SQ3)

- When the measuring result is outside (inside) the set limits.

Monitoring of alarm limits

The limit monitoring in a PM6652/54 may be performed in four different ways. An SRQ-alarm is given in the following cases:

- If the value(X) is outside the range a...b ($X < a$, $X > b$). "SQ2" must be programmed.
- If the value (X) is inside the range a...b ($a < X < b$). "SQ3" must be programmed.
- If the value (X) is below the limit c ($X < c$) "SQ2" and "SK1" must be programmed.
- If the value (X) is above the limit c ($X > c$) "SQ3" and "SK1" must be programmed.

In all the above cases a prerequisite is that the MATH function is enabled ("ME1"). The range a...b is set by using the MATH. constants K and L to appropriate values. If an SRQ-alarm is to be given for measuring values (X) outside the range a...b, then K and L should be selected:

$$K = \frac{1}{b - a} \qquad L = -\frac{a}{b - a}$$

For example: The counter must monitor a frequency with a nominal value of 455kHz. The counter should not send anything on the bus as long as the frequency falls inside the range 450...460kHz.

When the measured frequency falls outside that range, a SRQ is sent to the controller.

$$a = 450 \times 10^3 \qquad b = 460 \times 10^3$$

The constants K and L should be selected as:

$$K = \frac{1}{b-a} = \frac{1}{10 \times 10^3} = 10^{-4} \qquad L = -\frac{a}{10 \times 10^3} = -45$$

The counter should be programmed as follows:

1. Set K = 10^{-4} ("SK1E-4")
2. Set L = -45 ("SL-45")
3. Enable Math ("ME1")
4. Activate alarm Monitoring ("SQ2")

There is a special case: When K is set to 1, the counter monitors whether the measured value (X) is above or below a limit value (c). To get a SRQ-alarm if $X > c$ then K and L have to be selected as:

$$K = 1 \qquad L = -c$$

Example: An SRQ should be sent when a time interval measurement results in a value higher than 400ms. In this case $K = 1$ and $L = -0.4$. The counter should be programmed as follows:

1. Set K = 1 ("SK1")
2. Set L = -0.4 ("SL-0.4")
3. Enable Math ("ME1")
4. Activate Alarm monitoring ("SQ3")

Limit monitoring is illustrated below:

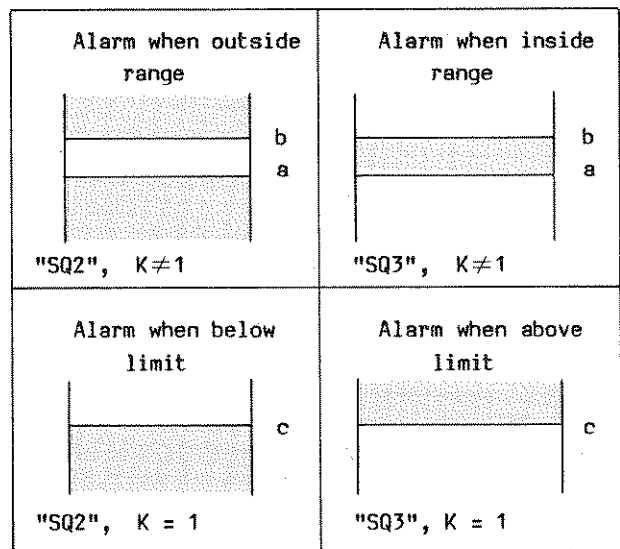

Fig. 5.3 Limit monitoring.

OUTPUT DATA

When the counter is an active "talker", the result of a measurement is transmitted to the controller over the IEEE-488 Bus. The output data from the counter can be of three different kinds.

- Programming status
- Status byte
- Normal measurement values.

Programming status strings

Programming status strings are of two kinds and consist either of a sequence of 8 strings with a total of 133 ASCII characters plus delimiters or an unreadable string of 43 ASCII-characters, defining the present programming status of the counter. They are sent out instead of a measurement value when instructed to do so by programming code "P0" or "P1" (Program data out). See section "Programming Codes" for details.

Status byte

A status byte is a one byte message sent by the PM 9696 interface logic as a response to a serial poll. The status byte contains information such as:

- Service requested by the counter? Yes/No
- Error condition? Yes/No
- Counter is busy or ready for new measurement

See also section "Status Byte".

Normal measurement values

A normal measurement result is sent from the counter as a string of ASCII characters, in accordance with the following format:

F	F	SP	0	X	X	X	X	X	X	X	X	X	X	X	E	±	X	D	(D)
---	---	----	---	---	---	---	---	---	---	---	---	---	---	---	---	---	---	---	-----

Bytes 1,2 FF = Function code (see table 5.4).

- Byte 3 Normally a space character. On overflow, 0 is sent.
- Bytes 4..14 XXXXXXXXXXXX means 11 characters containing the measurement value. 10 characters are digits and one is a floating decimal point.
- Byte 15 E is an exponent pointer.
- Byte 16 Exponent sign is + or -.
- Byte 17 Exponent value X is either 0 or multiples of ±3.
- Byte 18 Delimiter CR, LF, ETX or ETB
- Byte 19 Second delimiter LF (only if delimiter combination CR+LF has been selected).

Note: With negative values of math constants K and/or L the result might be negative. In this case a minus sign ("-") is sent instead of the last of the leading zeros. Example: "FA 000-1234.56E+3"

Leading zero suppression

When leading zero suppression is enabled (LE1), all leading zeros are removed from the output string. The object is to increase the output data transfer rate on the bus. The format is then no longer fixed. The following output data (without leading zero suppression):

F	A	0	0	0	0	0	0	1	2	.	3	4	E	+	3	LF
---	---	---	---	---	---	---	---	---	---	---	---	---	---	---	---	----

will be reduced to:

F	A	1	2	.	3	4	E	+	3	LF
---	---	---	---	---	---	---	---	---	---	----

with leading zero suppression.

Output of voltages and trigger levels

There are two exceptions to the normal output format. When trigger levels (code TL) or V_{max} , V_{min} (code VM) are sent, the output format will be:

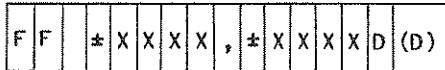

- Byte 1,2 Function code VM or TL
- Byte 3 Space character.
- Byte 4 Sign + or - for channel A (TL) or for V_{max} (VM).
- Byte 5...8 XXXX indicates the level for channel A (TL) or V_{max} (VM) in Volts. 3 characters are digits and one is a floating decimal point.
- Byte 9 Separating comma (,).
- Byte 10 Sign + or - for channel B (TL) or for V_{min} (VM).
- Byte 11...14 XXXX indicates the level for channel B (TL) or V_{min} (VM) in Volts. 3 characters are digits and one is a floating decimal point.
- Byte 15 Delimiter CR, LF, ETX or ETB
- Byte 16 Second delimiter LF (only if delimiter combination CR+LF has been selected).

Function codes

Codes	Functions
DF	Duty Factor A
FA	Frequency A
FC	Frequency C
HT	Hold-off Time
MT	Measuring Time
PA	Period A
PH	Phase A-B
PW	Pulse Width A
RA	Ratio A/B
RC	Ratio C/B
RT	Rise/Fall Time A
TG	Tot A gated by B
TI	Time Interval A-B
TL	Trigger Levels A, B
TM	Tot A, Manual
TS	Tot A, Start/Stop by B
VM	V_{max} , V_{min} A
VP	V_{pp} A

Table 5.4 Output function codes.

Output delimiter

The default delimiter can be set by jumpers on the PM 9696 circuit-board to be either CR, LF or CR+LF. If neither is selected ETX will be sent for single measurements (TE1) and ETB will be sent for repetitive measurements (TE0). The delimiter is factory preset at LF.

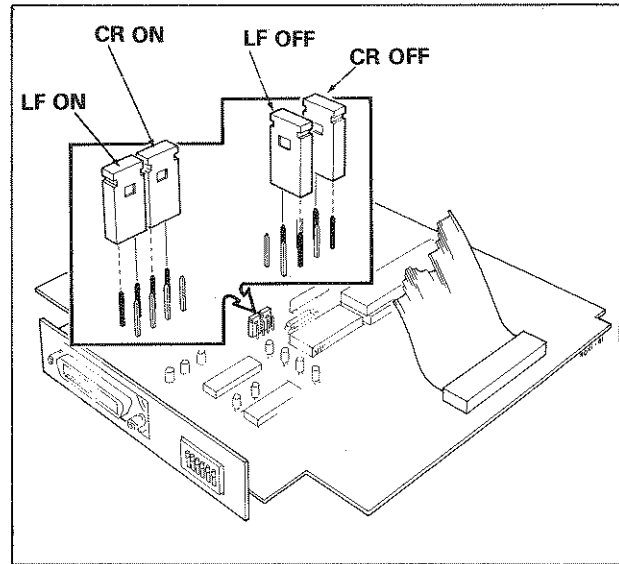

Fig. 5.4 Delimiter settings.

Choice of output string delimiters

The default value of the output delimiter is set by hardware jumpers on the PM 9696 circuit board (factory preset at LF).

The delimiter can be changed by the controller by sending "SD0", "SD1", "SD2" or "SD3".

Note: When SD0 is selected, the delimiter will be ETB in free running mode (TE0) and ETX in triggered mode (TE1).

The EOI-line in the IEEE-488 bus will be active together with the last output byte sent when "MS1" has been programmed.

STATUS BYTE

The status byte is a one byte status message that is sent from the counter to the controller as a response to a serial poll. The following format is used:

- Bit 8: Always 0.
- Bit 7: Service request has been sent (1) or not (0).
- Bit 6: Alarm condition (1) or not (0).
- Bit 5: Counter is busy (1) or ready (0).
- Bit 1-4: Counter status specification.

Service request (bit 7)

Is sent on the following conditions:

- If there is a programming error.
- After each measurement or test if "SQ1" is programmed.
- When set alarm limits are passed if "SQ2" or "SQ3" is programmed.
- After self-test errors.

Alarm (bit 6)

Alarm status occurs if:

- The counter is wrongly programmed.
- Set alarm limits are passed.
- Self-test errors.

Busy/ready (bit 5)

The counter is busy during the actual measurement and also during the preparation for the measurement. The counter is ready when the result is ready for output on the bus.

Normal measuring cycle

A normal measurement cycle consists of the following phases:

- Preparation for measurement.
- Waiting for a trigger command via the bus if "TE1" is programmed.
- Waiting for input signal synchronization to start.
- Measuring.
- Waiting for input signal synchronization to stop.

- Processing the counting register data.
- Output of the result.

The normal measuring cycle is illustrated below, fig. 5.5.

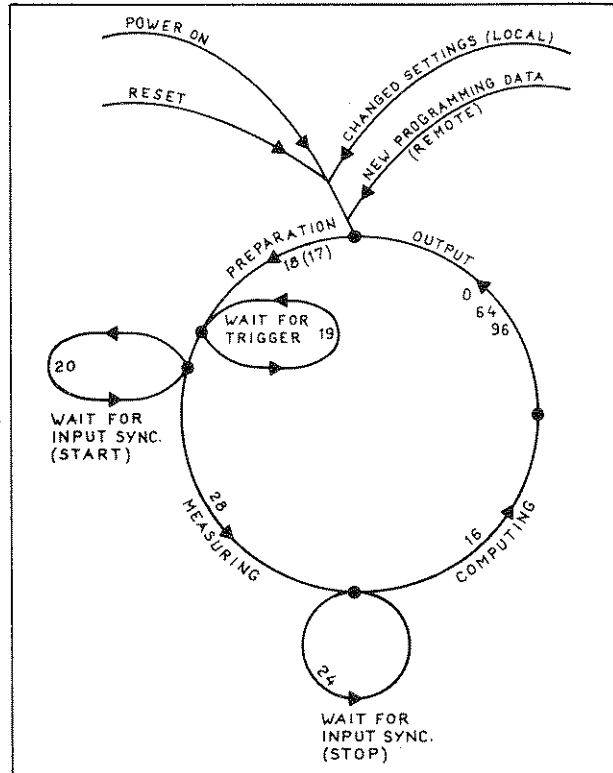

Fig. 5.5 Normal measuring cycle. (The numbers refer to status byte contents).

The status byte codes for the above phases are shown in Table 5.5. Note that the preparation phase can have two different codes depending on whether repetitive measurements (code TE0), or single measurements (triggered mode TE1) have been selected.

Status message	Binary	Decimal	
Preparation (TE0)	00010010	18	}
Preparation (TE1)	00010001	17	
Waiting for trigger TE1	00010011	19	
Waiting for start sync.	00010100	20	
Measuring	00011100	28	}
Waiting for stop sync.	00011000	24	
Computing	00010000	16	}
Ready for output	00000000	0	
Ready, with service req	01000000	64	
Limit alarm - " -	01100000	96	

Table 5.5

When triggered mode (TE1) has been selected, the counter makes all necessary preparations for a measurement (status 17) and then waits (status 19) for either a group execute trigger (GET) command via the bus or code "X" (execute).

If a GET command is received the counter will after a short delay synchronize with the input signal and start the measurement. If, however, an "X" is received, the counter will go through the preparation for measurement once again and then start the measurement.

Sending an "X" will result in a small delay (approx. 5ms) compared to the GET command.

The output phase (status 0, 64 or 96) terminates the measuring cycle. "Output" means output to both the display and to the IEEE-488 bus, if requested by the controller.

There are 3 different output states:

- Status 0 indicates a normal output without service request ("SQ0").
- Status 64 indicates a normal output with service request ("SQ1").
- Status 96 indicates limit alarm together with service request ("SQ2" or "SQ3").

Deviations from the normal measuring cycle are found when performing:

- Hold-off, measuring time and trigger level readings.
- Tests 1 through 6.
- Totalize A, Manual gating.
- High Speed Dump mode output.

Hold-off, Measuring time, Trigger levels

The reading of hold-off, measuring time or trigger levels results in the measuring cycle shown in fig. 5.6.

The normal output phase has status 8 and when SRQ is sent ("SQ1" is programmed), the status is 72. Limit monitoring, when selected ("SQ2" or "SQ3") is ignored in these measurements.

Status message	Binary	Decimal	
Measuring and computing	00011010	26	} busy
Ready for output	00001000	8	
Ready with service req.	01001000	72	

Table 5.6

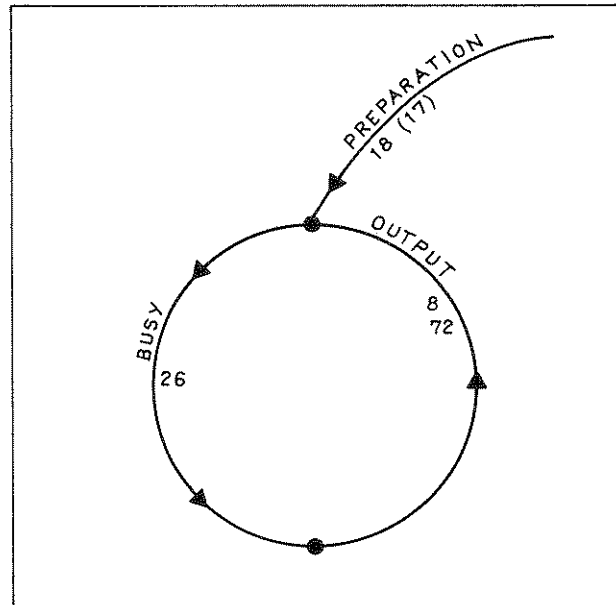

Fig. 5.6 Measuring cycle: HOLD-OFF, MEASURING TIME or TRIGGER LEVELS.

Tests 1...6

The measuring cycle when performing self-tests 1...6 (TS1...TS6) is illustrated in fig. 5.7.

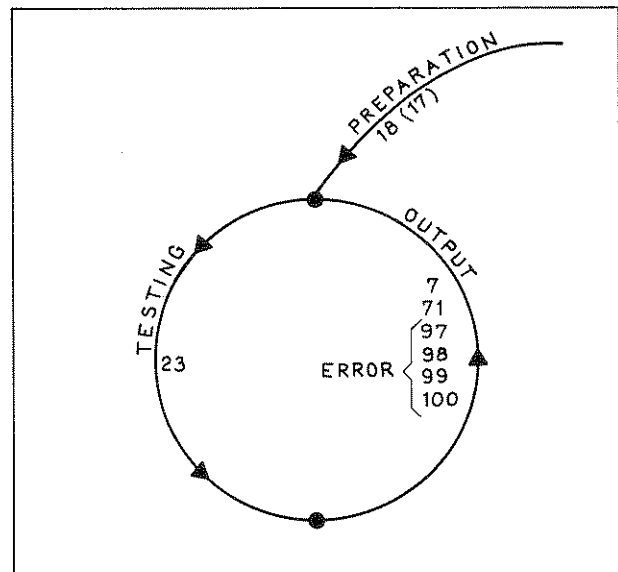

Fig. 5.7 Measuring cycle: TEST.

When the test is finished, the status byte contains 7 (without SRQ), 71 (with SRQ) or error codes 97...100 (with SRQ). If an error occurs, a mandatory SRQ is sent to the controller, even if the service request is disabled ("SQ0").

It is good practice to enable service request before performing a test. The completion of the test is then indicated by an active SRQ line. The alternative (if SQO is programmed) would be successive serial-polls until status byte 7 is recognized.

When test No. 6 is executed, a sequence of tests 1..5 is performed. When "SQ1" is programmed, the SRQ line will be active after the last test (No. 5).

The measuring cycle is summarised in table 5.7.

Status message	Binary	Decimal	
Testing	00010111	23	busy
Ready without service req	00000111	7	
Ready with service req.	01000111	71	ready
Error in test 1, with SRQ	01100001	97	
- " - test 2, - " -	01100010	98	
- " - test 3, - " -	01100011	99	
- " - test 4, - " -	01100100	100	

Table 5.7

Totalize A manual gating

The Totalize A manual gating mode, has a different measuring cycle. Unlike other measuring modes, the counter has no idea if or when the measurement is terminated and when the final result is ready. The only way to terminate a Totalize A manual measurement is to select another measuring function. Closing the manual gate will not terminate the measurement. The gate might, later, be opened for the totalizing to continue.

The contents of the counting registers are sensed approximately 50 times/second during the totalizing process. It is thus possible to follow the totalizing "continuously" (50 readings/sec.) via the bus.

The measuring cycle is illustrated in fig. 5.8. There are in principal only two phases: the registers and output of the result. These phases may have different status values, depending on whether the gate is open or closed.

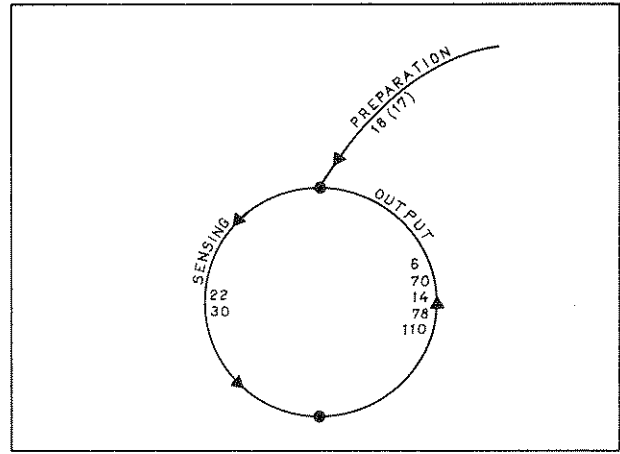

Fig. 5.8 Measuring cycle: TOTALIZE A.

Status message	Binary	Decimal	
<u>Gate open</u>			
Sensing	00011110	30	busy
Output	00001110	14	ready
Output with service req.	01001110	78	
Output with limit alarm	01101110	110	
<u>Gate closed</u>			
Sensing	00010110	22	busy
Output	00000110	6	ready
Output with service req.	01000110	70	

Table 5.8 Summarizes the measuring cycle.

High-speed dump mode

The measuring cycle for the high speed dump output is shown in fig. 5.9. The status byte has the binary value 00001100 (decimal 12) during dump mode.

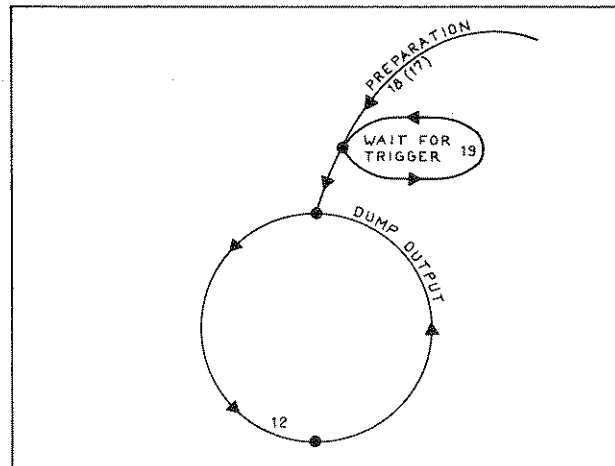

Fig. 5.9 Measuring cycle: HIGH SPEED DUMP MODE.

Miscellaneous

Programming errors will result in a mandatory SRQ and will also block any further operation of the counter. The counter will ignore the faulty programming codes (e.g. "F53") or the faulty range (e.g. "AL-300"). There are 4 ways to release the counter:

- a) Local mode.
- b) Read the status byte (serial Poll).
- c) Device clear.
- d) Program data out ("P0" or "P1").

After release of the counter the measuring cycle starts from the beginning with a new preparation phase. The status byte for programming errors is binary 01101111, decimal 111.

The counter can be busy performing tasks that are not found in the previous examples. This "undefined busy" status is binary 00010101, decimal 21. This status is, for example, temporarily present during the power up phase.

The SRQ-line in the IEEE-488 interface as well as bit No. 7 in the status byte are set to 1 in the following situations, at output (when requested by "SQ1"), when limits are exceeded (when requested by "SQ2" or "SQ3") or upon errors.

The SRQ-line and status bit No. 7 are reset in the following cases:

- Directly after a serial poll.
- When the counter receives new programming data.
- When the counter sends measuring data on the bus.

That means that in case of a SRQ, the controller should first of all make a serial poll to examine the status byte before any other bus actions are performed with the counter. Otherwise the information of a possible counter-SRQ is lost.

It is possible to find temporary status byte values that are not shown in table 5.9. If an alarm condition occurs (status 96, 97, 98, 99, 100, 110, 111) and the SRQ-bit is reset after a serial poll, an additional serial poll will result in status byte showing alarm without SRQ (status 32, 33, 34, 35, 36, 46, 47).

Summary

All possible status bytes, in ascending order, are summarized in table 5.9.

Status value	Status message	
0	00000000	Normal output
6	00000110	Output T.M., gate closed
7	00000111	Test ready
8	00001000	Output H.O., M.T., T.L.
12	00001100	Dump mode
14	00001110	Output T.M., gate open
16	00010000	Computing
17	00010001	Preparation ("TE1")
18	00010010	Preparation ("TE0")
19	00010011	Waiting for trigger
20	00010100	Waiting for input sync.to start
21	00010101	Busy, undefined task
22	00010110	Sensing T.M., gate closed
23	00010111	Performing Test
24	00011000	Waiting for input sync.to stop
26	00011010	Reading H.O., M.T., T.L.
28	00011100	Measuring
30	00011110	Sensing T.M., gate open
64	01000000	Normal output with SRQ
70	01000110	Output T.M. with SRQ, gate closed
71	01000111	Test ready with SRQ
72	01001000	Output H.O., M.T., T.L. with SRQ
78	01001110	Output T.M. with SRQ, gate open
96	01100000	Ready with limit alarm
97	01100001	Error in test No. 1
98	01100010	Error in test No. 2
99	01100011	Error in test No. 3
100	01100100	Error in test No. 4
110	01101110	Limit alarm, T.M., gate open
111	01101111	Programming error

H.O. = Hold-Off

M.T. = Measuring time

T.L. = Trigger levels

T.M. = Tot. A Manual gating.

Table 5.9

HIGH-SPEED DUMP MODE

Every normal measuring cycle include computation of the result (e.g. to get frequency). A calculation of the resolution (number of displayed digits) as well as display formatting is also performed. The duration of this computation phase is some 10 milliseconds.

This will limit the measuring speed to 20...50 readings/sec, even when a minimum measuring time (1...2µs) has been selected.

The use of high speed dump mode is a way to increase measuring speed to 400...500 readings/sec. (typical when minimum measuring time is selected). In this mode the microcomputer skips the computation phase and will just output the contents of decade count registers. The computation of the result as well as calculation of resolution must then be made by the controller.

The dump mode is entered by programming "HS1". When High Speed Dump mode has started the display will indicate "HS" instead of measuring values. There are four different ways to terminate the dump mode:

- Sending programming string "HSØ".
- Sending programming string "D".
- Sending bus commands SDC or DCL (device clear).
- Go to local mode.

The dump mode output string contains 24 or 25 ASCII characters, with the following format:



- byte 1 = Alphabetic code A...U specifying what calculation should be made.
- byte 2...23 = Register contents (numeric).
- byte 24 = Selected delimiter.
- byte 25 = Delimiter LF (only if delimiter CR + LF has been selected).

The 22 numeric characters normally represents the contents of the event count register and the time count register respectively.

In totalizing mode only event counts are represented in the numeric string. In single time measurements only time counts are represented. The following abbreviations are used:
 T = Time count register contents.
 E = Event count register contents.
 X = Don't care byte.
 D = Delimiter.

Individual bytes in the time count and event count registers are numbered e.g. T9, T5, E11, E1 etc. Least significant byte is called T1 and E1 resp. There are 6 different formats depending on the measuring function selected. There are as many as 21 possible ways of calculating the final result. The calculation algorithm to be used is indicated by the code (A...U) in byte No. 1.

Format No. 1

Functions:

PM 6652/54: Period, Phase, Duty Factor, Freq A, Ratio A/B, Time Average, Freq. C.

Output format:

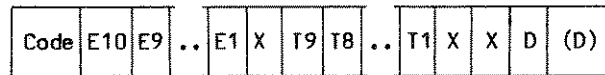

Byte 1 2 3 .. 11 12 13 14 .. 21 22 23 24 (25)

Calculation algorithms:	Code	Calculation
	C	$(T/E) \times 10^{-7}$
	G	$(T/E) \times 360$
	H	T/E
	K	$(E/T) \times 10^8$
	L	$(E/T) \times 10^7$
	O	$E/(T+1)$
	P	$(E/(T+1)) \times 10^{-7}$
	T	$(E/T) \times 16 \times 10^8$

Format No. 2

Functions:

PM 6654: Freq A, Freq C, Period A, Time Average
 PM 6652: -

Output format:

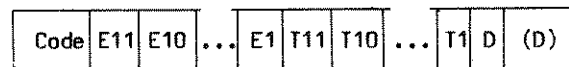

Byte 1 2 3 ... 12 13 14 ... 23 24 (25)

Calculation algorithms:	Code	Calculation
	J	$(E/T) \times 5 \times 10^8$
	M	$(E/T) \times 8 \times 10^9$
	N	$(T/E) \times 2 \times 10^{-9}$
	R	$(T/E) \times 10^{-8}$

Format No. 3

Functions:

PM 6654: Ratio A/B, Ratio C/B.

PM 6652: Freq. A, Freq. C, Ratio A/B, Ratio C/B.

Output format:

Code	E11	E10	...	E1	T9	T8	...	T1	X	X	D	(D)
------	-----	-----	-----	----	----	----	-----	----	---	---	---	-----

Byte 1 2 3 ... 12 13 14 ... 21 22 23 24 (25)

Calculation algorithms:

Code	Calculation
A	$(E/(T+1)) \times 10^7$
B	$(E/(T+1)) \times 16 \times 10^7$
D	$E/(T+1)$
E	$16 \times E/(T+1)$

Format No. 4

Functions:

PM 6652/54: Single Time, Single period, Tot. A gated by B, Tot A start/stop by B.

Output format:

Code	T19	T18	..	T10	X	T9	..	T1	X	X	D	(D)
------	-----	-----	----	-----	---	----	----	----	---	---	---	-----

Byte 1 2 3 .. 11 12 13 .. 21 22 23 24 (25)

Calculation algorithms:

Code	Calculation
F	$T \times 10^{-7}$
S	T

Format No. 5

Functions:

PM 6654: Single period, single time.

PM 6652: -

Output format:

Code	T21	T20	...	T12	X	T11	...	T1	D	(D)
------	-----	-----	-----	-----	---	-----	-----	----	---	-----

Byte No: 1 2 3 ... 11 12 13 ... 23 24 (25)

Calculation algorithms:

Code	Calculation
Q	$T \times 2 \times 10^{-9}$

Format No. 6

Functions:

PM 6652/54: Tot. A gated by B, Tot. A start/stop by B, Single ratio A/B, single ratio C/B.

Output format:

Code	E20	E19	..	E11	E1	E10	..	E2	X	X	D	(D)
------	-----	-----	----	-----	----	-----	----	----	---	---	---	-----

Byte 1 2 3 .. 11 12 13 .. 21 22 23 24 (25)

Calculation algorithms:

Code	Calculation
I	E
U	$16 \times E$

PROGRAM EXAMPLES

The following programs will demonstrate how PM 6654 or PM 6652 communicate with an HP 85 controller.

Program No. 1 will make any desirable number of frequency measurements and calculate the mean value, standard deviation and max/min values.

Program No. 2 is simpler and much shorter. Ten period measurements are made and only the mean value is calculated and displayed.

Program No. 3 asks the operator for a programming string which is sent directly to the counter, whereafter the correspondent measuring value is displayed. This program is illustrated with a lot of hard-copy print-outs.

Program No. 4 illustrates the "Program data out" command.

Program No. 5 gives an example how the limit monitoring with service request alarm can be used.

Program No. 6 finally, shows how the HP85 is programmed for High speed dump mode using the so called FHS-technique (FHS = Fast Hand Shake). The dump mode output format is also illustrated.

The output delimiter in the PM 9696 interface should be set to LF (Line feed) when a HP 85 controller is used.

If the counter will not communicate with the controller, i.e. the counter cannot be addressed, there will be no input data, or the counter cannot be programmed remotely. Press the RESET pushbutton on the HP 85 and/or press the POWER ON/OFF switch on the counter and try again. If the counter still doesn't communicate, check:

- All connectors of the IEEE-488 bus.
- The trigger LED indicators. If the input signal is lost, the counter might not terminate the measurement.

- The address switch on the counter rear panel must be set to 10 (binary 01010).
- The output string delimiter in the PM 9696 interface should be set to LF when a HP controller is used.

Program No. 1

The number of samples, which must not exceed 1000, is given by the operator (INPUT statement). The counter is programmed to measure FREQ A (default value) with a 10ms measuring time. The device address of the counter is 10.

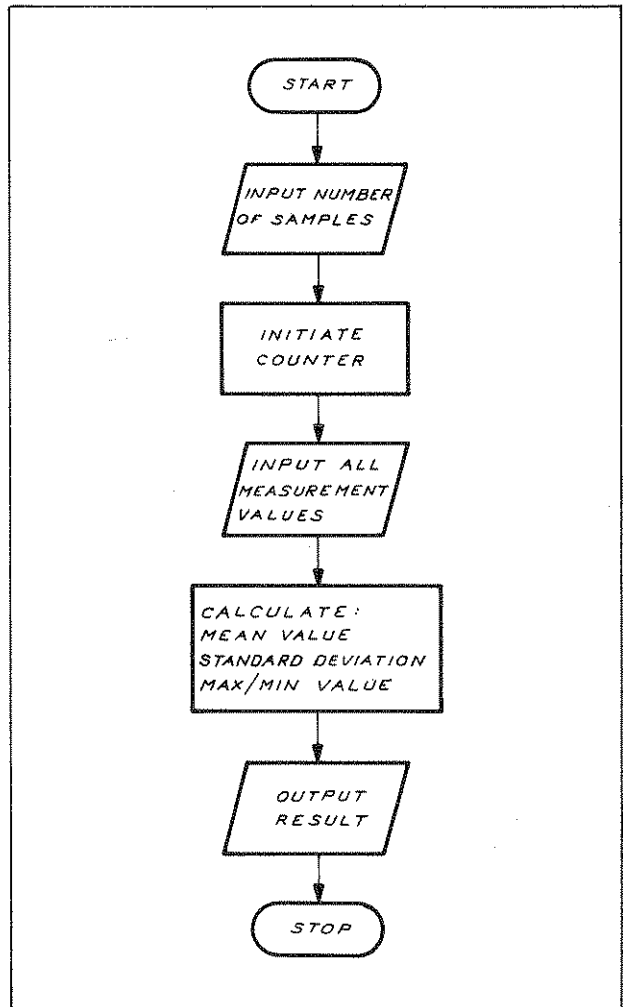

Fig. 5.10 Program No. 1 flow-chart.

Program No. 2

The counter is programmed to do 10 PERIOD measurements with 1s measuring time. See flow-chart below.

```

10 ! IEC-BUS PROGRAM 1 FOR
20 ! PM 6652/54 COUNTERS
30 ! AND HP 85 AS CONTROLLER
40 !
50 PRINT
60 PRINT "FREQUENCY MEASUREMENT
S"
70 PRINT
80 CLEAR ! CLEAR DISPLAY SCREEN
90 BEEP ! WAKE-UP SIGNAL
100 DISP "HOW MANY SAMPLES?"
110 INPUT Q
120 ! CLEAR AND SET DEFAULT
130 ! VALUES IN PM9696-INTER-
140 ! FACE
150 CLEAR 710
155 WAIT 100
160 ! SET 10 ms MEASURING TIME
170 ! AND TRIGGER (X)
180 OUTPUT 710 ; "SM1E-2,X"
190 DIM A(1000)
200 ! INPUT ALL SAMPLE VALUES
210 FOR N=1 TO Q
220 ENTER 710 ; A$
230 A(N)=VAL(A$E4)
240 NEXT N
250 ! CALCULATE MEAN VALUE
260 M=0
270 FOR N=1 TO Q
280 M=M+A(N)
290 NEXT N
300 M1=M/Q
310 ! CALCULATE ST. DEVIATION
320 S2=0
330 FOR N=1 TO Q
340 S2=S2+(M1-A(N))^2
350 NEXT N
360 ! CALCULATE MAX AND MIN
370 H=A(1)
380 L=A(1)
390 FOR N=2 TO Q
400 IF A(N)>H THEN H=A(N)
410 IF A(N)<L THEN L=A(N)
420 NEXT N
430 ! OUTPUT ALL PARAMETERS
440 PRINT "NUMBER OF SAMPLES=";Q
450 Y=1
460 IF M1<100000 THEN Y=10
470 IF M1<10000 THEN Y=100
480 IF M1<1000 THEN Y=1000
490 IF M1<100 THEN Y=10000
500 IF M1<10 THEN Y=100000
510 IF M1<1 THEN Y=1000000
520 PRINT "AVERAGE=";
530 PRINT INT(M1*Y)/Y; "Hz"
540 PRINT "ST. DEVIATION=";
550 PRINT INT(SQR(S2/Q)*Y)/Y;
560 PRINT "Hz"
570 PRINT "MAX VALUE=";H;"Hz"
580 PRINT "MIN VALUE=";L;"Hz"

```

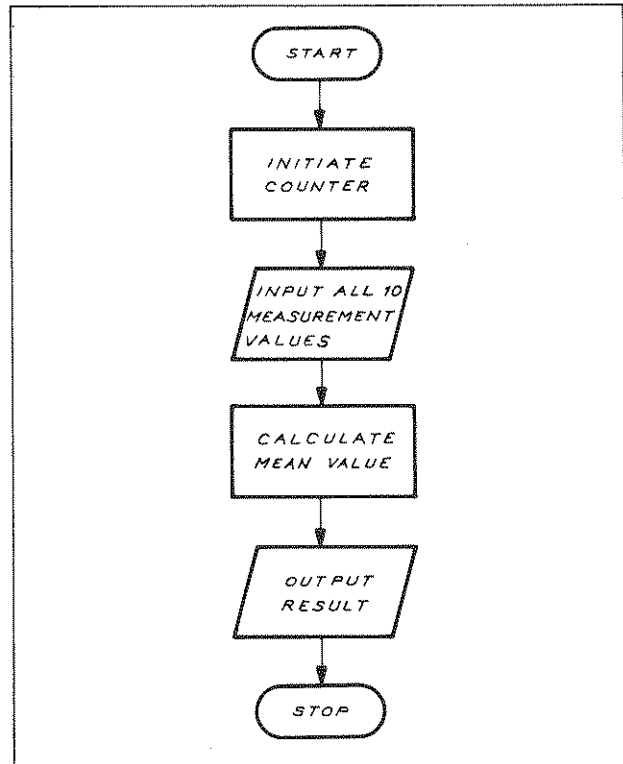

Fig. 5.11 Program No 2 flow chart.

```

10 ! DEMO PROGRAM NO 2
20 ! FOR PM 6652/54 AND
30 ! AND HP 85 AS CONTROLLER
40 !
50 CLEAR ! CLEAR DISPLAY
60 CLEAR 710 ! DEFAULT SETTINGS
70 ! SELECT PERIOD A (F3)
80 ! AND 1s MEASURING TIME
90 OUTPUT 710 ; "F3SM1"
100 ! INPUT ALL SAMPLE VALUES
110 Z=0
120 FOR N=1 TO 10
130 TRIGGER 710
140 ENTER 710 ; A$
150 Z=Z+VAL(A$E4)
160 NEXT N
170 ! GET MEAN VALUE
180 M=Z/10
190 ! DISPLAY MEAN VALUE
200 DISP "AVERAGE=";M;"s"
210 END

```

Program no 3.

This program asks the operator for a programming string to be sent to the counter. After that a measuring value is entered and displayed for 5 seconds. See flow-chart below.

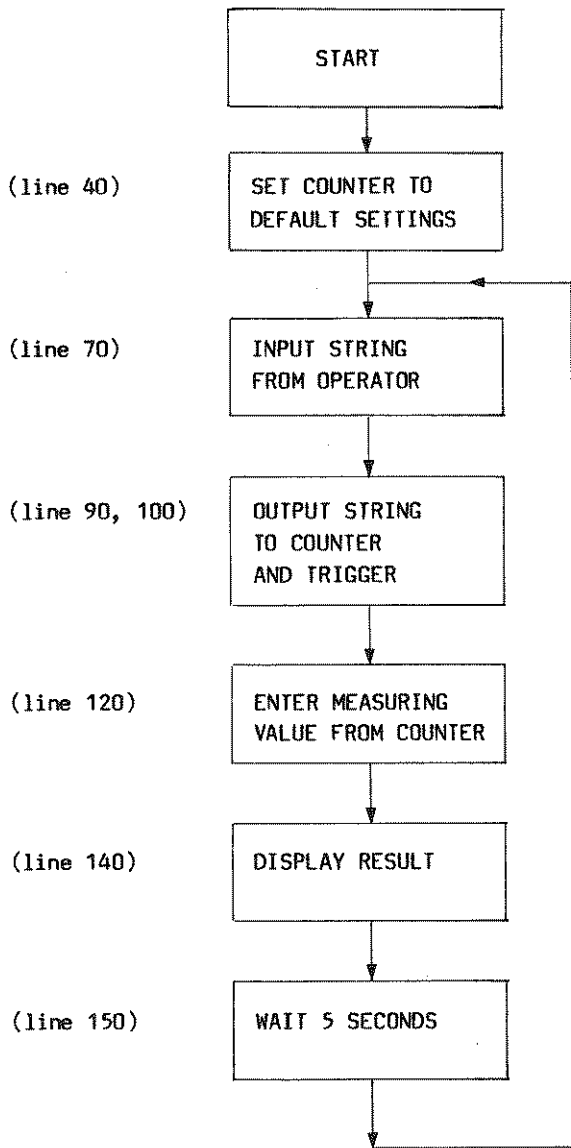

Fig 5.12. Program no 3 Flow chart

The program listing is shown below.

```

10 ! DEMO PROGRAM NO 3
20 ! FOR PM6652/54 AND
30 ! HP85 AS CONTROLLER
40 CLEAR 710 ! CLEAR COUNTER
50 CLEAR ! CLEAR DISPLAY
60 DISP "INPUT YOUR PROGRAMMING
   STRING"
70 INPUT A$
80 ! PROGRAM THE COUNTER AND TR
   IGGER
90 OUTPUT 710 ;A$
100 TRIGGER 710
110 ! GET THE MEASURING RESULT
120 ENTER 710 ; B$
130 DISP
140 DISP "RESULT IS: ";B$
150 WAIT 5000 ! WAIT 5 SECONDS
160 GOTO 50
170 END
  
```

To illustrate the program running, the measuring results are copied from the HP85 display to the integral thermal printer.

- a) To measure Frequency A with 1s measuring time, it is not necessary to program Frequency measurements because that is the default function. The programming string is simply: "SM1" (Set Measuring time = 1s).

```

INPUT YOUR PROGRAMMING STRING
?
SM1

RESULT IS: FA 084.8633289E+3
  
```

- b) The result was a 9 digit result for 1 second measuring time (correct). In changing measuring time to minimum by means of string "SS1" (set Single/minimum):

```

INPUT YOUR PROGRAMMING STRING
?
SS1

RESULT IS: FA 00000084.87E+3
  
```

- c) There are now only 4 digits for approx. 2 μ s measuring time. But the readout is difficult to read with 6 leading zeroes. To remove all leading zeroes by means of string "LE1" (Leading zero suppression Enable):

```
INPUT YOUR PROGRAMMING STRING
?
LE1
RESULT IS: FA 84.87E+3
```

- d) Which gives a much nicer print-out. To measure period A instead, first program "D" (Default setting) followed by F3 (Function 3 = period).

```
INPUT YOUR PROGRAMMING STRING
?
DF3
RESULT IS: PA 011.7831194E-6
```

- e) To measure the duty factor of the signal (code "F10").

```
INPUT YOUR PROGRAMMING STRING
?
F10
RESULT IS: DF 0000869.649E-3
```

- f) To make a fast Duty Factor measurement by programming:

"SS1" for shortest possible Measuring time
 "SM1E-4" for shortest possible Display time
 "LE1" for leading zero suppression

```
INPUT YOUR PROGRAMMING STRING
?
SS1SM1E-4LE1
RESULT IS: DF 0.88E+0
```

- g) To determine the rise time of the input signal, program:

"F9" for Rise Time function
 "SS0" and "SM10E-3" for 10ms meas. time.
 "AC0" for DC-coupled inputs
 "AT1" for 50 Ohm termination

```
INPUT YOUR PROGRAMMING STRING
?
F9SS0SM10E-3AC0AT1
RESULT IS: RT 1.48238E-6
```

- h) To discover the trigger levels used for the previous rise time measurement, program: "RL1" (Read trigger Levels).

```
INPUT YOUR PROGRAMMING STRING
?
RL1
RESULT IS: TL +0.02,+0.68
```

- i) To examine the input voltage, V_{max} and V_{min} by using "F14" and "RL0" (switch off read trigger level mode).

```
INPUT YOUR PROGRAMMING STRING
?
RL0F14
RESULT IS: VM +0.75,-0.06
```

- j) To use the 20% and 80% trigger points instead (20% is +0.10V and 80% is +0.59V), the programming codes used are:

"TL1" for Trigger Level via keyboard
 "AL.10" for channel A level = 0.10V
 "BL.59" for channel B level = 0.59V
 "RL1" for checking our set levels

```
INPUT YOUR PROGRAMMING STRING ;
?
TL1AL.1BL.59RL1
RESULT IS: TL +0.10,+0.59
```

Program no. 4

This program displays the current programming status of the counter as a result of a "P0"-command.

The "P0"-command will result in an output of 8 consecutive program data strings which are input to the HP85 and displayed.

At the end of the program there is a "LOCAL 710" statement. This enables manual changes of the counter settings before re-running the program with new programming status.

The listing is shown below.

```
10 ! DEMO PROGRAM NO 4
20 ! FOR PM6652/54 AND
30 ! HP85 AS CONTROLLER
40 CLEAR
50 DISP
60 ! ASK FOR PROGRAM DATA OUT
70 OUTPUT 710 ; "P0"
80 DIM P$(25)
90 ! ENTER AND DISPLAY 8 STRING
  S
100 FOR K=1 TO 8
110 ENTER 710 ; P$
120 DISP P$
130 NEXT K
140 ! RETURN TO LOCAL MODE
150 LOCAL 710
160 END
```

A display readout (copied to the integral thermal printer) is shown below.

```
F01SM60.E-3SS0
AC1AS0AA0AT1AL+0.00
BC0BS0BA0BT0BL+0.00
TL2TO0CE0CH0TE0
S00HS0LE0MS0SD2
G0HE0ME0RM0RH0RL0
SK+000000001.E+00
SL+000000000.E+01
```

After having made some manual changes on the front panel, a new "RUN" resulted in the following print-out. Note the changed settings.

```
F03SM10.E-1SS1
AC1AS0AA0AT1AL+0.12
BC1BS1BA1BT1BL+0.00
TL1TO0CE0CH0TE0
S00HS0LE0MS0SD2
G0HE0ME1RM0RH0RL0
SK+000000001.E+06
SL-000000011.E+00
```

Program no 5

This program activates an upper and a lower limit for frequency measurements. When the frequency exceeds the set limits, an SRQ is sent to the controller, which will display the erroneous value together with the limits.

To activate the limit alarm the counter must be programmed with the following commands (see line 200):

- "SK..." and "SL..." to set the relevant K and L values
- "ME1" to enable MATH
- "SQ2" to enable limit alarm SRQ

The SRQ interrupt is enabled in line 130. Line 120 instructs the HP85 where to go in case of an interrupt (i.e. line 230). The SRQ-interrupt routine starts with a "STATUS" statement which clears the interrupt cause register (CR1) in the HP85. Furthermore, a serial poll (line 260) is executed to "take away" the active SRQ line in the bus. A test is made (line 270) to see whether the SRQ interrupt was caused by limits exceeded (status 96) or by something else.

At the very end (line 430), there are some necessary statements to enable further monitoring after the first SRQ interrupt.

- "SEND 7; UNT" means that the counter is told to "untalk", otherwise the counter will not measure but wait forever for a handshake procedure with the HP85.

- "TRIGGER 710" is needed to start further measurements.
- "ENABLE INTR 7;8" is needed to re-enable SRQ interrupts.

The listing is shown below:

```

10 ! DEMO PROGRAM NO 5
20 ! FOR PM 6652/54 AND
30 ! HP85 AS CONTROLLER
40 LOCAL 710
50 CLEAR ! CLEAR SCREEN
60 DISP "INPUT LOWER LIMIT:"
70 INPUT A
80 DISP "INPUT HIGHER LIMIT:"
90 INPUT B
110 ! ENABLE SRQ-INTERRUPT
120 ON INTR 7 GOTO 230
130 ENABLE INTR 7;8
140 ! CALCULATE K AND L
150 K=1/(B-A)
160 L=-A/(B-A)
170 K$="SK"&VAL$(K)
180 L$="SL"&VAL$(L)
185 CLEAR 710 ! DEFAULT SETTINGS
190 ! OUTPUT DESIRED K AND L VAL
UES, ENABLE MATH AND ENABLE
LIMIT ALARM MONITORING
200 OUTPUT 710 ;K$&L$&"SQ2ME1"
210 GOTO 210
220 ! INTERRUPT ROUTINE
230 STATUS 7,1 ; D
240 BEEP
250 DISP @ DISP
260 S=SPOLL(710)
270 IF S=96 THEN 340
280 DISP "SERVICE REQUESTED FOR"
290 DISP "OTHER REASONS"
300 ENABLE INTR 7;8
310 DISP "PRESS 'END LINE' TO RE
START"
320 INPUT D$
330 GOTO 440
340 ENTER 710 ; B$
350 DISP "MEASUREMENT RESULT:"
360 DISP " ";(VAL(B$[4])-L)/K
370 DISP "HAS EXCEEDED LIMITS:"
380 DISP A;" AND ";B;" RESP."
390 DISP
400 DISP "DO YOU WANT TO CONTINU
E THE"
410 DISP "MEASUREMENT? (Y/N)"
420 INPUT R$
430 IF R$="Y" THEN SEND 7 ; UNT
@ TRIGGER 710 @ ENABLE INTR
7;8 @ GOTO 210
440 END

```

The hard-copy output of a test run is shown below:

```

INPUT LOWER LIMIT:
?
70E3
INPUT HIGHER LIMIT:
?
80E3

MEASUREMENT RESULT:
61153.306
HAS EXCEEDED LIMITS:
70000 AND 80000 RESP.

DO YOU WANT TO CONTINUE THE
MEASUREMENT? (Y/N)
?

```

Program no 6

This program example demonstrates how 1000 single period measurements can be transferred in a few seconds to HP85 using High speed dump mode.

For this purpose HP85 must be programmed for "Fast Handshake Transfer" (FHS) using a large I/O-Buffer (25000 bytes is used in the program). In High speed dump mode every measuring result contains 24 bytes. This explains line 170 which says: "Transfer data from the counter (address 710) to the 25000 byte I/O-buffer B\$ using Fast Hand-Shake (FHS) and do not stop until 1000 measurements (24000 bytes) have been counted!"

The program listing is shown on next page.

```

10 ! DEMO PROGRAM NO 6
20 ! FOR PM 6652/54 AND
30 ! HP85 AS CONTROLLER
40 CLEAR
50 DISP
60 DISP "HIGH SPEED DUMP MODE"
70 DISP "1000 PERIOD MEASUREMENT
  S"
80 DISP
90 ! DIMENSION I/O-BUFFER
100 DIM B$(25000)
110 IOBUFFER B$
120 CLEAR 710
130 ! PROGRAM SINGLE PERIOD, KEY
  BOARD SET LEVEL (0V) AND DUM
  P MODE
140 OUTPUT 710 ; "F3SS1TE1HS1TL1"
150 TRIGGER 710
160 ! HIGH SPEED INPUT TRANSFER
170 TRANSFER 710 TO B$ FHS ; COU
  NT 24000
180 OUTPUT 710 ; "HS0"
190 FOR I=0 TO 99
200 FOR K=0 TO 9
210 DISP B$(240*I+24*K+1,240*I+2
  4*K+23)
220 NEXT K
230 DISP "PRESS 'CONT' TO SEE MO
  RE!"
240 DISP "(MEASUREMENTS NO";10*I
  +1;"TO";10*I+10;"ARE NOW SHO
  WN)"
250 PAUSE
260 CLEAR
270 NEXT I
280 DISP "THAT'S ALL"
290 END

```

A hard-copy printout is shown below. The first byte is code "Q" saying that all bytes (except byte No 12) contain time counts and that the data should be multiplied by 2 ns to get the correct result. In this example we see that the periods are 218 or 220 ns.

```

00000000000400000000109
00000000000400000000109
00000000000400000000109
00000000000400000000110
00000000000400000000109
00000000000400000000109
00000000000400000000109
00000000000400000000109
00000000000400000000109
00000000000400000000109
00000000000400000000109
PRESS 'CONT' TO SEE MORE!
(MEASUREMENTS NO 231 TO 240
ARE NOW SHOWN)

```

See section "High speed dump mode", page 5.19 ("Format No 5") for a detailed explanation.

NOTE: If ENTER is used instead of TRANSFER at line 170, the number of measurements/second will be reduced by approximately 50%.

Chapter 6

OTHER OPTIONS

CONTENTS	Page
Introduction	6-2
Channel CPM 9610.....	6-2
Rear inputsPM 9611.....	6-2
Fan unitPM 9612.....	6-3
OscillatorsPM 9678, -79, -90, -91...	6-3
Analog recorder outputPM 9695.....	6-4
Frequency multiplierPM 9697.....	6-5
Blind panel	6-5

INTRODUCTION

This chapter contains the operating manuals for all options for the counters PM 6652,-54 with exception of the IEEE-bus interface (PM 9696), which is included in chapter 5 of this manual. The technical specification for each option is included in chapter 9. Mounting instructions for the options are included in the service manual.

WARNING: Mounting of the different options shall only be carried out by personel qualified to do so. To reduce the risk of electric shock do not perform any form of servicing other than that specified in the operating manual unless you are fully qualified to do so.

Please note that some options e.g. Blind panel, Fan unit and Rear inputs are factory options.

CHANNEL C PM 9610

With the option PM 9610 is the frequency range for PM 6652,-54 extended to 1.5 GHz. This HF-input is on the front panel marked input C.

The C channel option is principally a prescaler which divides the input frequency by 16. For example, an input frequency of 800 MHz will be counted by the counting logic as if it were a 50 MHz signal; see Fig. 6.1.

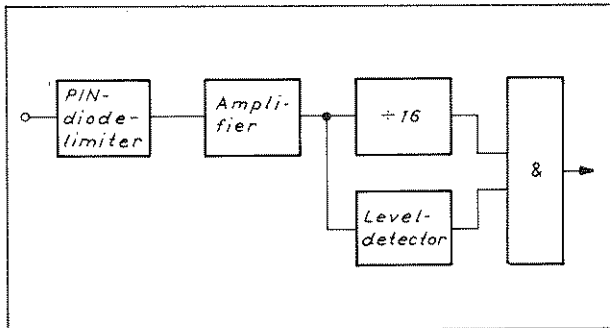

Fig. 6.1 Input C block diagram

A signal level detector enables counting only when the input level is high enough. Below that level no measurement at all is made. A "clean drop-out" is thus provided and no erroneous measurements are made on RF noise. This circuit is automatically disabled* when the C-input is used for FREQ.AVG. measurements to improve the burst capability.

*) Not on the PM 6652,-54.

NOTE: If FREQ. C and AVG. is selected and the C-input left open, the display will show a false readout instead of being blanked out.

The input amplifier is automatically protected against signal levels above +10 dBm. This enables a wide dynamic range of $10 \text{ mV}_{\text{RMS}} \dots 12 \text{ V}_{\text{RMS}}$ and excellent overload protection.

Amplitude modulated signals can be measured as long as the minimum amplitude in the modulation envelope is higher than the sensitivity of the C-channel (see fig. 6.2).

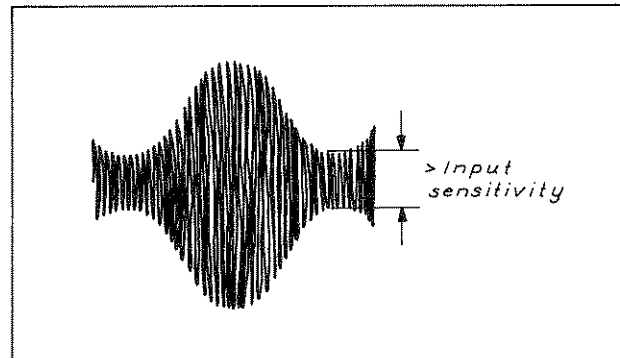

Fig. 6.2 Amplitude modulated signals can be measured down to $10 \text{ mV}_{\text{RMS}}$.

REAR INPUTS PM 9611

The rear inputs PM 9611 is a factory mounted option. With this option are the front panel inputs A, B and C substituted by the rear panel inputs K, L and M.

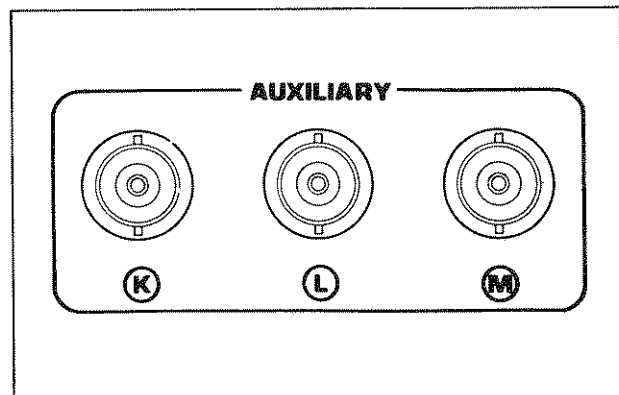

Fig. 6.3 The rear panel inputs K, L and M.

In order to preserve the 50 Ohm input impedance it is necessary to disconnect the front panel inputs when installing the rear panel inputs.

FAN UNIT PM 9612

The fan unit is designed for applications where the environmental temperature increases to over 40 °C and the natural air circulation is prohibited. There must anyhow be sufficient free space available around the counter (at least 20 mm).

In order to make the fan unit efficient there must be sufficient free air available around the counter. The ventilation holes for the fan is located in the side panels at both sides of the counter.

The fan unit is a factory option.

OSCILLATORS PM 9678, -79, -90, -91

The frequency of the reference crystal oscillator is the main accuracy defining parameter in a counter. The frequency is effected by external conditions like the ambient temperature and supply voltage but also by ageing.

When making a recalibration, the reference crystal oscillator is only compensated for deviation in frequency due to ageing.

Some important points:

- The high stability oscillators has been built into an oven in order to keep the oscillator temperature as stable as possible. Continuous operation is also important for the stability. After a mains-voltage interruption the oscillator restarts at a slightly different frequency. It will then, as time goes on follow an equal ageing rate.
- The stabilities indicated for the oscillators are valid within a temperature range of 0...-50 °C, with a reference temperature of 23 °C. If the counter is used in a room temperature of 20...30 °C, the temperature stability will be increased with a factor of 3.
- The temperature stability indicated for TCXO and standard oscillators are mainly dependent on the ambient temperature. At power on there is always a temperature increase inside the counter which will influence the oscillator.

Recalibration

The Mean Time Between ReCalibration, MTBRC, is defined as:

$$\text{MTBRC} = \frac{\text{Acceptable error} - \text{Temp. stability}}{\text{Ageing}}$$

It can be calculated when the total acceptable error and the oscillator specifications are known.

The total acceptable error is defined as:

$$\text{Acceptable error} = \frac{\text{Deviation of ref. frequency}}{\text{Nominal ref. frequency}}$$

Example:

- A user can accept a maximum of ± 3 Hz deviation on the 10 MHz frequency of the oscillator, this results in:

$$\text{Acceptable error} = \frac{3}{10 \times 10^6 \text{ Hz}} = 3 \times 10^{-7}$$

The Ageing and temperature factors can be selected from the table in Chapter 9.

The value of the Ageing factor is correctly selected from the table when the calculation of MTBRC results in 1...30 days, 1...12 months or over 1 year (not e.g. 43 days or 17 month or 0.8 years).

Example:

- The user has the same requirements as in the example above. The counter has an oscillator PM 9690.
- Look up information about PM 9690 in the Technical Specification, Chapter 9. The results will be the following:

Relative Frequency deviation caused by:

Ambient temperature variation:	Less than 3×10^{-8}
Ageing/year:	Less than 1.5×10^{-7}

- Use the MTBRC formula with the above values. This gives a MTBRC of maximum:

$$\frac{3 \times 10^{-7} - 3 \times 10^{-8}}{1.5 \times 10^{-7}} = 1.8 \text{ year}$$

NOTE: When making a recalibration, the reference crystal oscillator will only be compensated for relative frequency deviation caused by ageing.

ANALOG RECORDER OUTPUT PM 9695

The PM 9695 converts the digital information of the PM 6652/54 counters into an analog signal. One application for the analog output is for recording the stability of oscillators and filters on a strip chart recorder. In frequency control systems with analog feedback, the DAC serves as an accurate frequency to voltage converter.

Output and switches

The analog output signal from the PM 9695 is sent out via a BNC connector on the rear panel. A resolution selector and an offset switch are used to select the desired output digits.

Resolution selector

Any 3 consecutive digits can be selected with the 12-position resolution selector. The converter functions as a magnifying glass to focus on the desired part of the read-out. The resolution selector has two scales. One scale (marked s) is for time measurements from 10^{-13} s to 10^{-2} s. The other scale (marked Hz) is used for voltage, degrees, ratio, counts and frequency, from 10^{-4} to 10^7 . See Fig. 6.4.

The position of the resolution selector corresponds to the least significant of the digits selected.

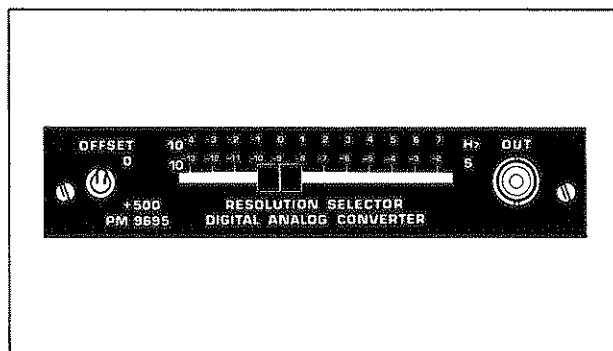

Fig. 6.4 The digital-to-analog converter panel with the resolution selector.

When the resolution selector is set to a position where one or two of the digits to be converted are outside the display of the counter, then these digits will be converted as zeros.

At power on or reset, the output is 0mV. If an overflow occurs on the converter display, the analog output will be 1023mV.

Some examples

If the display shows 1 2 3 4 5 6 7 8 9 kHz and the resolution selector is set to 10^3 Hz as indicated in the left-hand column below, then the digits 123 (marked in the middle column, example 1) are converted to an analog output signal. This is shown in Table 6.1, together with some additional examples.

Position of resolution selector, upper scale	Converted digits	Analog output signal
10^3 Hz	123.456789	123mV
10^2 Hz	123.456789	234mV
10^4 Hz	123.456789	012mV
10^{-4} Hz	123.456789	890mV

Table 6.1

Offset switch

In normal operating mode, the offset switch should be set to position 0. The analog output is then directly proportional to the digital input, which means that 000 produces 0.000V and 999 produces 0.999V.

For offset mode operation, the offset switch is set to position +500. This adds 500 to the digital input, and 500 then produces 0.000V, whereas 499 produces 0.999V. Thus, for a display changing between 9.99999999MHz and 10.00000000MHz, the frequency will be recorded at the center of the strip chart, rather than shooting between zero and full scale.

REFERENCE FREQUENCY MULTIPLIER PM 9697

With this option installed, the PM 6652/54 counters can accept external reference frequencies of 1MHz, 5MHz or 10MHz via input D (EXT STD IN) on the rear panel. The multiplier can however only be installed together with the standard oscillator.

Selection of multiplication factor

The selection of multiplication factor has to be reconsidered at installation (see instruction manual PM 9697) or change of external reference.

Note that only trained personnel are allowed to work with an opened instrument.

- Disconnect the mains cable.
- Remove the top cover of the counter.
- Find the two jumpers BU103 and BU104 on PM 9697, see Fig. 6.5.

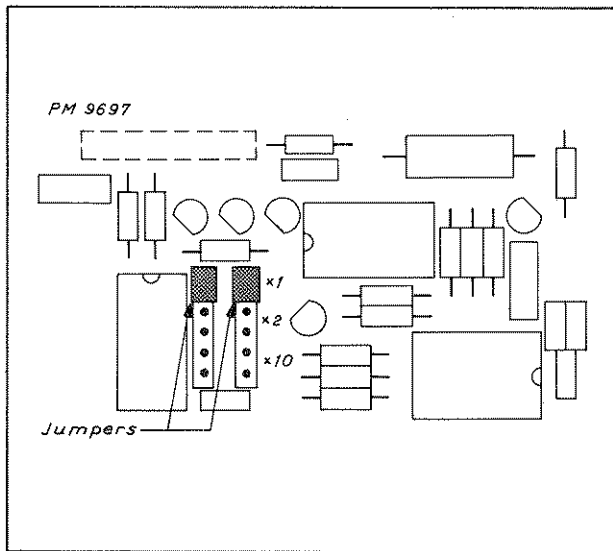

Fig. 6.5 Component layout PM 9697.

- If necessary change the jumpers.
- Refit the cover.

BLIND PANEL

Counters used only in IEEE-BUS applications, may from the factory be equipped with a blind panel. The counter is still electrically identical to the "normal" version.

The blind panel includes:

- Three input connectors A, B and C. These inputs can be substituted by the rear panel inputs K, L and M (PM 9611).
- One potentiometer, protected by a screw-fastened cover, for setting the HOLD OFF time, which cannot be set via the IEEE-BUS.
- The secondary power switch.
- Three LED:s on the left hand side of the panel, indicating: POWER ON, REMOTE and STAND BY.

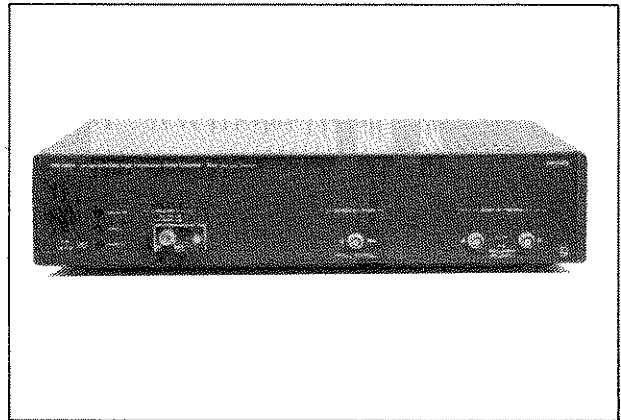

Fig. 6.6 Blind panel for counters PM 6652/54.



Chapter 7

MEASUREMENT THEORY

CONTENTS	Page
Introduction	7-2
Input triggering	7-3
Measuring time and resolution	7-6
Measuring modes	7-6
Special functions	7-11

INTRODUCTION

The microcomputer-based PM 6652 and PM 6654 timer/counters provide a wide range of frequency and time measuring functions, including time interval, rise or fall time, phase, duty factor, etc. The counters also offer voltage measurements such as V_{max} , V_{min} and V_{pp} of the input signal. A summary of all possible measuring functions is given below:

<u>Frequency related measuring functions:</u>	<u>Time related measuring functions:</u>
Frequency A	Time interval
Frequency C	Pulse width
Ratio A/B	Rise or fall time
Ratio C/B	Phase
Period A	Duty factor
Totalize (3 modes)	

Voltage measuring functions:

V_{max} , V_{min} , V_{pp}

Block diagram

The counters contain two microprocessors and a "counter-on-a-chip" LSI. The LSI, together with the input circuit, performs all counting functions; whereas the master microprocessor controls the logic functions of the counter and does all calculations on the counting result. The slave microprocessor performs the communication between control panel (controls, indicators and the display) and the master processor.

The microprocessors computing power allows mathematical manipulations of the result (offset and/or scaling). The PM 6652/54 also features automatic truncation of digits so that only significant digits are displayed. Thus, no overflow can occur. A block diagram is shown in Fig. 7.1. Two identical input channels are used for accurate time interval measurements.

The PM 6652 and PM 6654 have identical measuring functions. The difference is found in the input synchronization and in the internal clock pulse frequency. The PM 6652 operates with a clock frequency of 10MHz, whereas the PM 6654 operates with a clock frequency of 500MHz in most measuring functions.

The PM 6654 has a synchronization network that operates at 500MHz, 100MHz or 10MHz depending on the measuring function.

- 500MHz operation is found in Frequency A or C, Period and Single Time measurements.
- 100MHz operation is found in average time measurements (time interval, pulse width, rise and fall time) totalize modes and time.
- 10MHz operation is found in phase, duty factor and ratio.

In any measuring function, the use of hold off or external gate will automatically convert the PM 6654 to 10MHz clock frequency operation. The use of AVG (average) in time measurements will automatically result in 10MHz operation, whereas the AVG function in frequency or period measurements will not affect the resolution.

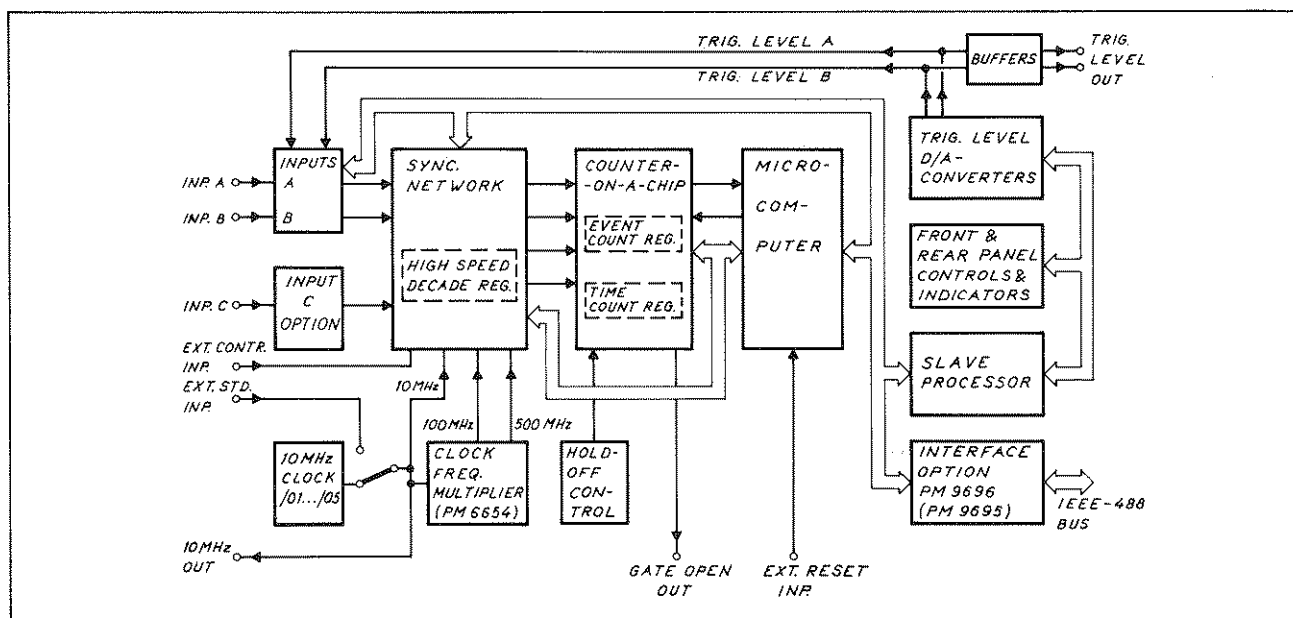

Fig. 7.1 Block diagram PM 6652/54

Clock frequency:	500MHz	100MHz	10MHz
Resolution:	2ns	10ns	100ns
Frequency A or C, Period	X		
Single Time Interval	X		
Multiple Time Interval AVG		X	
Totalize		X	
Phase, Duty factor, Ratio,			X
External gate, Hold-off			X
AVG and Frequency A or C	X		
AVG and Time average			X

Table 7.1 Resolution vs function in PM 6654

INPUT TRIGGERING

Functions - Channel A and B

As the input signal can have very different wave forms, it is necessary to shape the signals so that the counting circuits can handle the signals. The input circuits must be able to trigger on narrow pulses, signals superimposed on DC levels, noisy signals and low level signals as well as on high level signals. The input must also have selectable impedance (1M Ω /50 Ω) to fit various system configurations. The input circuits consist of:

- A 1M Ω /50 Ω input termination selector;
- AC/DC-coupling selector;
- An input attenuator (x10), to attenuate excessive input signals to fit the $\pm 5V$ trigger level off-set range;

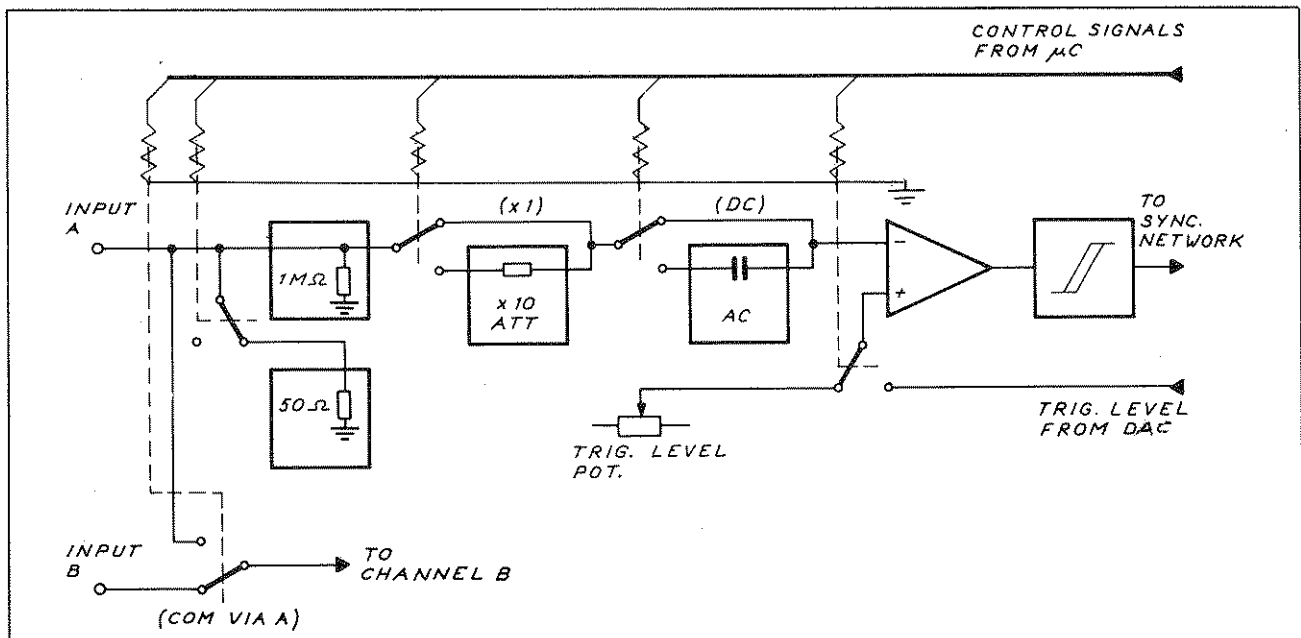

Fig. 7.2 Block diagram of the input circuits.

- A differential amplifier for trigger level setting;
- Schmitt trigger circuit with fixed hysteresis band (trigger window) for pulse shaping.

Schmitt-trigger function

The Schmitt-trigger function is illustrated in Fig. 7.3.

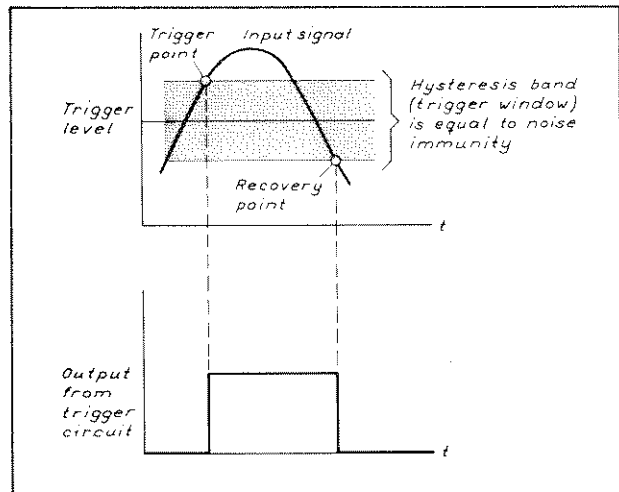

Fig. 7.3 Illustration of the trigger function.

The hysteresis band (trigger window) is centered around the trigger level and the width of the hysteresis band at the input is the same as the effective input sensitivity in V_{pp} .

Trigger level settings

When the trigger level setting is changed, the hysteresis band is shifted with respect to the input signal; see fig 7.4

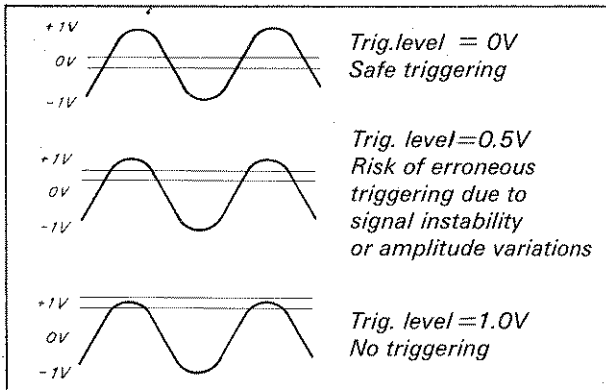

Fig. 7.4 Trigger level offset.

For reliable triggering the trigger level should, in almost all cases, be positioned at 50 % of the signal's peak-to-peak voltage. This is assured by the counter's AUTO trigger function.

When AUTO is selected, the microcomputer, not the operator, is doing the trigger level setting. The microcomputer will automatically measure max and min values of the input voltage, calculate the mid-value and position the trigger level accordingly. For rise or fall time measurements, the microcomputer will calculate trigger levels as the 10% and 90% values of the input voltage. If necessary, the microcomputer will automatically change the attenuator setting ($\times 1$ or $\times 10$). AUTO requires a repetitive input signal $> 100\text{Hz}$.

Trigger level can also be set manually via the keyboard or with the potentiometers. The range is $-5\text{V} \dots +5\text{V}$. The trigger level is set in 10mV steps via the keyboard. The real trigger level with respect to the input signal is then:

$$(\text{Attenuator setting}) \times (\text{Keyboard setting})$$

The set trigger level can also be read on the display with 10mV resolution for all three trigger level modes (AUTO, KEYBOARD, Potentiometers)

Frequency measurements

Timer/counters are used for both frequency and time interval measurements. However, frequency

and time interval measurements have contradictory requirements in respect of correct triggering. For frequency measurements, too narrow a hysteresis band (i.e. too high a sensitivity) means that the counter is too sensitive to noise; see Fig. 7.5. The hysteresis band is the noise immunity band.

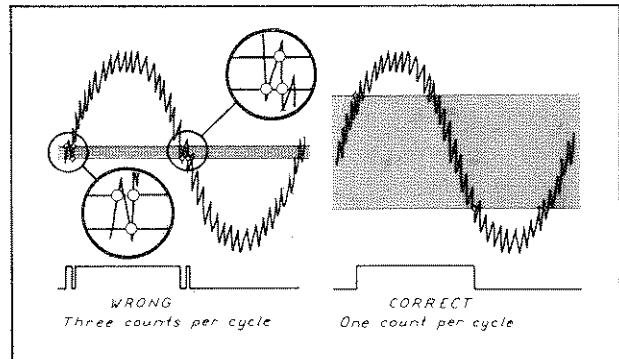

Fig. 7.5 Do not use a higher sensitivity than needed for correct triggering.

Signals which are superimposed on a DC voltage, must be separated via a capacitor (i.e. AC-coupling). The advantages of AC coupling are:

- No DC drift.
- Good protection against DC overload.

AC coupling, however, gives a drop in sensitivity for very low frequencies.

When measuring low frequency signals with superimposed high-frequency noise, one can use the HOLD-OFF as a low-pass filter with a variable cut-off frequency for input signals between 5Hz and 150kHz . For optimal noise rejection, set HOLD-OFF time to approx. $3/4$ of the input signal's period duration. The function of HOLD-OFF is illustrated in Fig. 7.6.

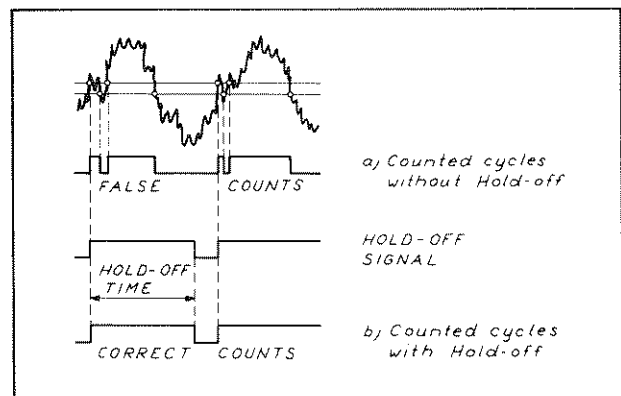

Fig. 7.6 HOLD-OFF acts as a noise rejection filter.

After the first triggering the HOLD-OFF period starts; during which time the counter is unable to perform any further input triggering. The selected Hold-Off time should expire when the signal is at maximum amplitude, to enable recovery and the start of a new Hold-Off at the beginning of the next pulse.

Time interval measurements

For time interval measurements, too wide a hysteresis band (i.e. too low a sensitivity), means that different signal slopes at the start and stop trigger point cause different delays between the trigger level crossing and the trigger point; see Fig. 7.7.

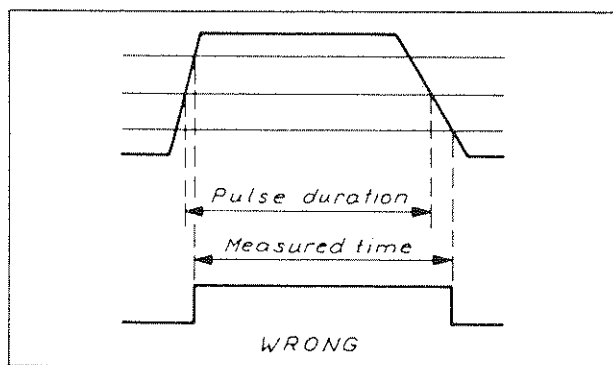

Fig. 7.7 Too wide a hysteresis might cause incorrect time interval measurements.

Systematic trigger errors are kept at a very low level thanks to the narrow hysteresis band (40 mV_{pp}) and the microcomputer controlled automatic hysteresis compensation. The resultant maximum trigger level error is only 5 mV_{pp}; see Fig. 7.8.

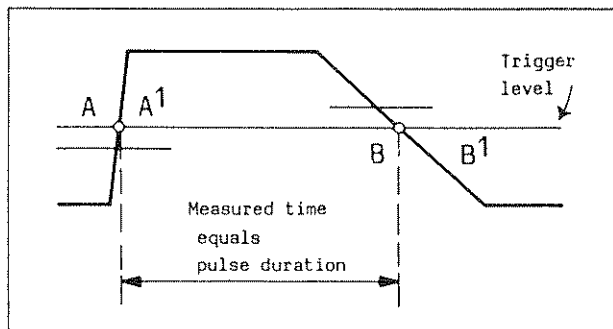

Fig. 7.8 Systematic trigger level errors are reduced with hysteresis compensation.

By lowering the trigger level on positive trigger slopes and raising it on negative slopes, one can compensate for the error due to hysteresis.

However, a calibrated input attenuator is necessary to enlarge the trigger level setting range. A separate x10 attenuator, which expands the trigger level range to -50 V...+50 V is available on the PM 6652,-54.

DC-coupling, trigger slope selection and a continuously variable setting of the trigger level is necessary for setting the trigger level at any required point of the input signal, independent of waveform or duty factor. Two identical inputs are also necessary to minimize the systematic channel mismatch error.

Input C

The counters have an optional RF input (input C) which extends the frequency measuring range up to 1.5 GHz.

The C channel option is principally a prescaler which divides the input frequency by 16. For example, an input frequency of 800 MHz will be counted by the counting logic as if it were a 50 MHz signal; see Fig. 7.9.

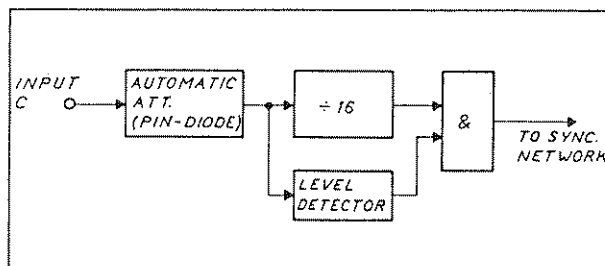

Fig. 7.9 Input C block diagram

The input signal is automatically attenuated over a wide range by means of a PIN-diode attenuator. This enables a wide dynamic range of 10 mV_{RMS}...12 V_{RMS} and excellent overload protection.

A signal level detector enables counting only when the input level is high enough. Below that level no measurement at all is made. A "clean drop-out" is thus provided and no erroneous measurements are made on RF noise.

To improve the burst-measuring capability, the level detector is automatically disabled* when the input C is used for FREQ.AVG.

NOTE: If the input C is left open in FREQ.AVG. mode, the display will show a false read-out.

*) Not on PM 6652,-54, only on PM 6652C,-54C

MEASURING TIME AND RESOLUTION

The measuring time can be varied in 33 steps per decade between 0.1ms and 96s. Using the MINIMUM/SINGLE measuring time push button gives a minimum gate time of 1...2µs for (e.g.) frequency measurements. Minimum/single gives a single period measurement when (e.g.) PERIOD A is selected. The set measuring time can be displayed by pushing the READ measuring time push button. This resets the counter and a new measurement will start. In the reciprocal mode, the counter totalizes input cycles until the set measuring time has elapsed and the synchronization conditions are met. Hence, the effective measuring time (also called gate time) is longer than the set measuring time.

The number of cycles (N) is:

$$N = \frac{\text{Effective measuring time}}{\text{Period duration}}$$

NOTE: When measuring frequency with PM 6652, "N" is always rounded to the nearest higher multiple of 10.

When the measuring time has elapsed, the micro-computer reads the count registers and computes the measuring result with an 11-digit resolution. The number of digits displayed, however, is limited only to the significant digits, depending on the measuring resolution. This measuring resolution is defined by the input frequency and the measuring time.

The number of digits is selected in such a way that the measuring resolution is equal to 0.2...2 units of the least-significant digit (LSD), where:

$$\text{LSD} = \frac{5 \times \text{Frequency}}{\text{Meas.time} \times 10^9 \text{Hz}} \quad \text{or} \quad \frac{5 \times \text{Period} \times 10^{-9} \text{s}}{\text{Meas. time}}$$

for the PM 6654 and:

$$\text{LSD} = \frac{2.5 \times \text{Frequency}}{\text{Meas.time} \times 10^7 \text{Hz}} \quad \text{or} \quad \frac{2.5 \times \text{Period} \times 10^{-7} \text{s}}{\text{Meas. time}}$$

for the PM 6652.

MEASURING MODES

Frequency A or C, Period A

The PM 6652/54 perform frequency and period measurements as given in the definitions:

$$\text{Frequency} = \frac{\text{Number of cycles}}{\text{Time}}$$

$$\text{Period} = \frac{\text{Time}}{\text{Number of cycles}}$$

The counter:

- Measures the effective measuring time.
- Counts the number of input cycles during the measuring time.
- Computes the number of cycles per second (frequency) or time units per cycle (period).

The measurement in the PM 6654 is always synchronized with the input signal. This is called the input synchronized or reciprocal method.

In the input synchronized mode, both the opening and closing of the main gate are synchronized with the input signal, so that only completed input cycles are counted. This means that a ±1 input cycle error is avoided. During the gate time, the counter also totalizes the number of clock cycles; see Fig. 7.10.

The resolution in the input synchronized mode is caused by truncation of the clock pulses, which results in a ±1 clock pulse error (2ns or 100ns). The resolution of the measurement thus only depends on the measuring time. For example, the resolution for 1s measuring time is 10⁻⁷ (100ns/1s) for the PM 6652 and 2 x 10⁻⁹ (2ns/1s) for the PM 6654, independent of input frequency.

In conventional counters, the gate time is synchronized with the clock signal. The first and last input cycle can therefore be truncated, causing a ±1 cycle error. This results in a good resolution for high frequency measurements, but a poor resolution for low frequency measurements (±1/frequency for 1s measuring time).

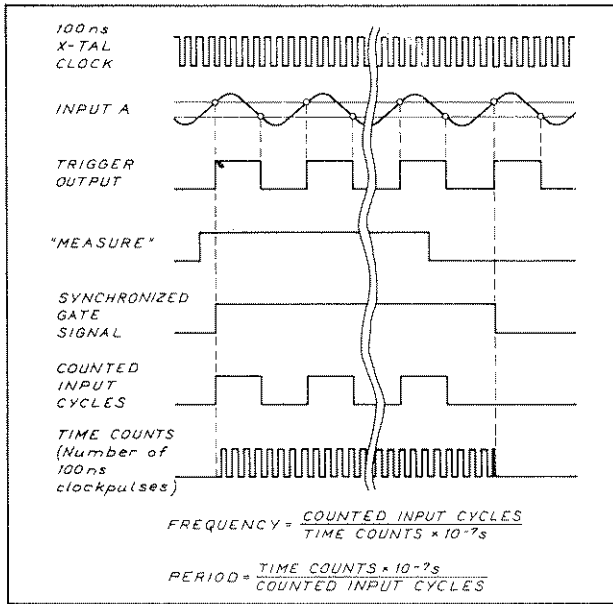

Fig. 7.10 Input synchronized mode.

For this reason, the PM 6652 uses input synchronized mode (reciprocal) for frequencies up to 10MHz and clock synchronized mode (conventional) above 10MHz. This ensures optimal resolution for all frequencies.

The PM 6654 with its very fast internal clock, uses the reciprocal mode for all frequencies.

Fig 7.11 and 7.12 shows the relative resolution of PM 6652 and PM 6654 for 1s measuring time.

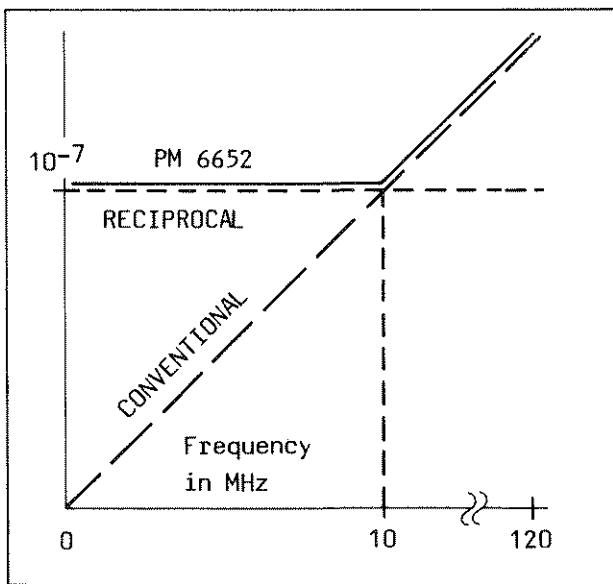

Fig 7.11 The resolution of PM 6652

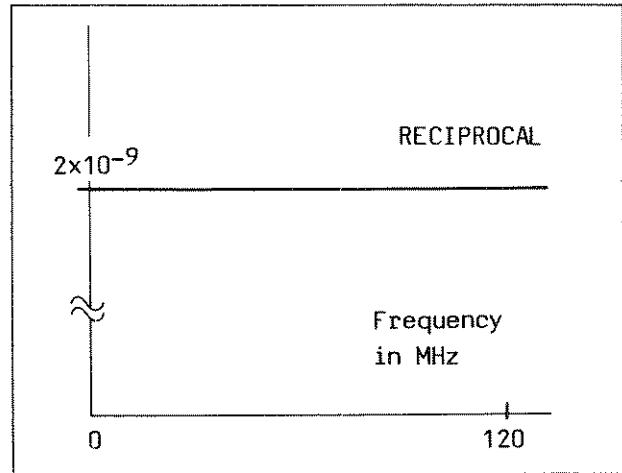

Fig. 7.12 The resolution of PM 6654

Frequency measurements on channel C (FREQ C) are made in the conventional mode in the PM 6652 and in the reciprocal mode in the PM 6654. The resolution in the PM 6654 remains the same as for FREQ A, i.e. 2×10^{-9} for a measuring time of 1s.

Depending on the conventional mode in the PM 6652 and on the 'divide by 16' prescaler, the resolution is 16 times the resolution of a FREQ A measurement, i.e.:

$$\text{Rel. resolution} = \frac{16}{\text{FREQUENCY C}} \quad (\text{for } 1s)$$

The resolution for 1s measuring time varies over the FREQ C range from 1.6×10^{-7} (at 100MHz) to 1.1×10^{-8} (at 1.5GHz).

Ratio measurements

The counters measure the frequency ratio between signals connected to input A and input B or between the input signals on channel C and channel B.

A ratio measurement is useful, for instance, when calibrating oscillators with an odd frequency. For example, say that the frequency should be 4.3625872MHz. This is difficult to recognize on the display. By connecting such a reference signal to input B and measuring the ratio instead, the oscillator is correctly calibrated when the display shows 1.0000000, which is much easier to read.

When MINIMUM/SINGLE measuring time is selected, the counters perform a single ratio measurement: that is, the counter will count the number of input cycles on channel A or C during one single period on channel B.

Totalizing of events

There are three different modes of totalizing.

Manual:

the counter totalizes events at input A, during the time interval between releasing and depressing the START/STOP TOTALIZE A push button. An event is defined as a positive-going transition.

Gated by B:

the counter totalizes events at input A, between the leading and trailing edge of the input B signal.

Start/Stop by B:

the counter totalizes events at input A, between the start and stop event at input B.

Time interval single measurements

Time interval measurements are made in modes TIME A-B, RISE/FALL TIME A and PULSE WIDTH A. Single time intervals are measured when MINIMUM/SINGLE measuring time is selected. Otherwise, an average measurement is made.

In TIME A-B single mode, the time (i.e. number of 100ns or 2ns clock pulses) is measured between a start event at channel A and a stop event at channel B. The start and stop triggering can be set individually with respect to: coupling, trigger level, slope and attenuation (x1 or x10).

In single source TIME measurements (RISE/FALL TIME and PULSE WIDTH) only input A is connected. The input B connector is disconnected. However, channel B is internally connected to input A. Channel B will automatically get the same attenuation, coupling and input termination as channel A.

Single channel time intervals can also be measured in the TIME A-B mode by pushing the COM pushbutton. In this case, the input impedance setting of channel B is disconnected (identical to that of channel A). The coupling, attenuation, trigger level and slope in channel B can still be set independently of the channel A setting. The resolution of the single measurement is 1 clock pulse (2 or 100ns).

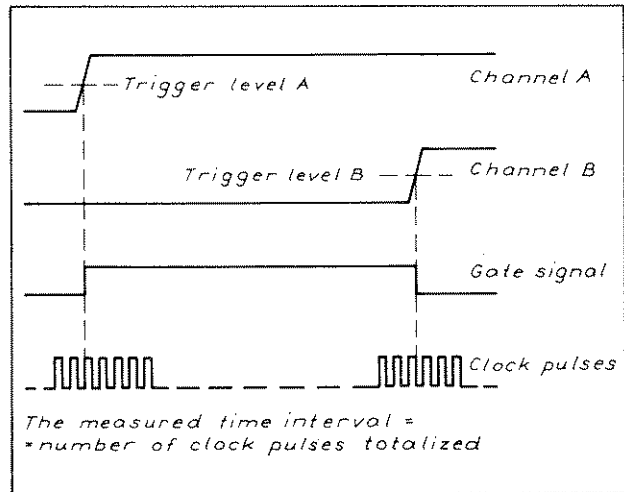

Fig. 7.13 Time interval single mode.

Pulse width measurements

These measurements are similar to single time interval measurements. When PULSE WIDTH A is selected, the counter automatically:

- Activates COM via A;
- Sets trigger level B = trigger level A;
- Sets coupling B = coupling A;
- Sets attenuation B = attenuation A;
- Sets slope B = inverse slope A.

When AUTO triggering is selected, the counter automatically sets the trigger level to 50% of the pulse amplitude in channel A. Note that AUTO requires a repetitive input signal > 100Hz.

Rise/fall time measurements

Rise or fall time measurements (RISE/FALL time) are very similar to TIME A-B measurements. When RISE/FALL time is selected, the counter automatically:

- Activates COM via A function;
- Sets coupling B = coupling A;
- Sets attenuator B = attenuator A;
- Sets slope B = slope A.

A rise time measurement is selected by choosing positive trigger slope A; fall time by choosing negative slope. When AUTO triggering is selected (in a rise time measurement), the counter also sets trigger level A to 10% and trigger level B to 90% of the Vpp value. For fall time measurements (negative slope on input A), the trigger levels are automatically set to 90% in channel A and 10% in channel B.

Time interval average measurements

By using the time interval average technique, which means multiple measurements of a repetitive signal, the measuring accuracy and resolution are greatly improved. Compared to single time interval measurements, the basic 2ns or 100ns resolution is improved by a factor of 1/V N, where N is the number of time intervals being averaged.

$$N = \frac{\text{Measuring time}}{\text{Pulse repetition time}}$$

Averaging of TIME A-B, RISE/FALL time A and PULSE WIDTH A measurements are normally performed as long as MINIMUM/SINGLE measuring time is not selected. When using time interval average, the number of leading edges of the clock pulses occurring in each individual "time window" are totaled. Fig. 7.14 illustrates a rise-time measurement.

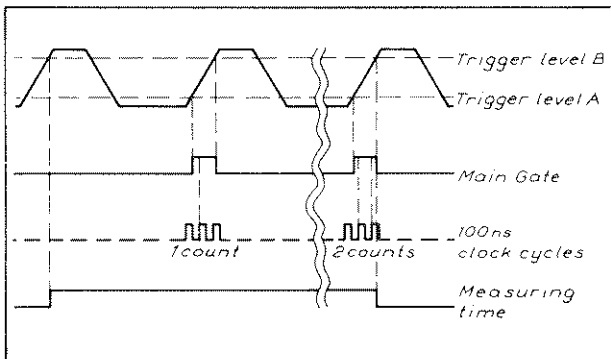

Fig. 7.14 Time interval average mode, PM 6652.

For a signal as illustrated in Fig. 7.14, approximately 10000 time intervals are being averaged during a measuring time of 10ms. Say that 6000 are measured as 200ns (2 clock cycles) and 4000 as 100ns. The statistical average is calculated in the microcomputer. In this case the average is 160ns. The resolution is $100\text{ns}/\sqrt{10000} = 1\text{ns}$.

Note that the input signal must be repetitive and asynchronous with respect to the time base and that the minimum dead time from stop to start is 50ns for the PM 6654 and 250ns for the PM 6652.

In time interval average mode in the PM 6654, the internal clock resolution is 10ns, not 2ns as in single shot measurements. The PM 6652 has the same internal clock resolution (100ns) for both average and single measurements.

Phase delay measurements

The timer/counters can measure the phase delay between two signals connected to inputs A and B. The measurement is performed by simultaneously measuring the time interval A-B and period. The phase delay is calculated as:

$$\text{Phase delay} = \frac{\text{Time Interval A-B}}{\text{Period}} \times 360^\circ$$

The measurement is made as an average measurement to improve accuracy and resolution; see Fig. 7.15.

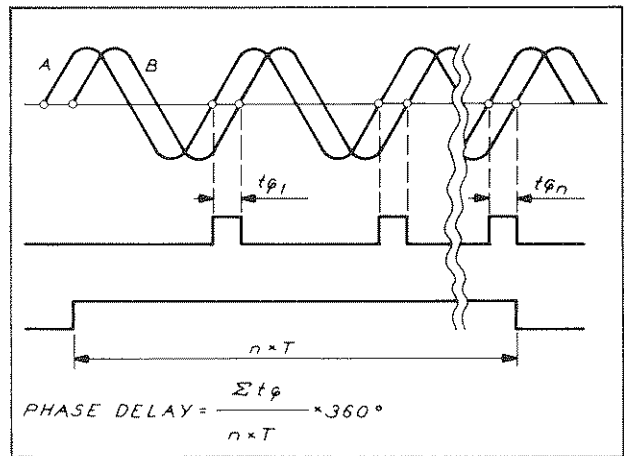

Fig. 7.15 The phase delay measurement.

In order to obtain a high accuracy time interval measurement in the phase delay function, the setting of the trigger level is very important. The trigger levels should be identical for both channels and as close to zero as possible. This is normally achieved with AC coupling and trigger levels = 0mV. Unequal settings of the trigger levels will result in inaccurate time interval measurements; see Fig. 7.16.

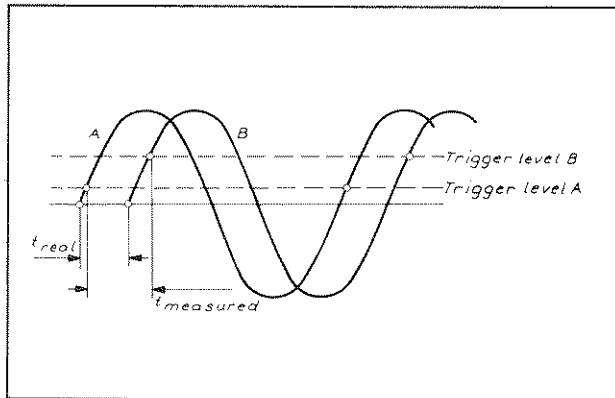

Fig. 7.16 Unequal settings of the trigger levels will result in inaccurate time interval measurements.

Very large differences in slew rate between the two signals, can result in a systematic phase error, which can be up to 1.5° . This is caused by the hysteresis band (typically $\pm 5mV$ after hysteresis compensation). Although the trigger level is set to 0mV, the actual trigger point could be +5mV. With variations in slew rate, the time before crossing the +5mV limit will vary. It is therefore important to keep the signals at about equal amplitude (sine and triangular waves). see Fig. 7.17.

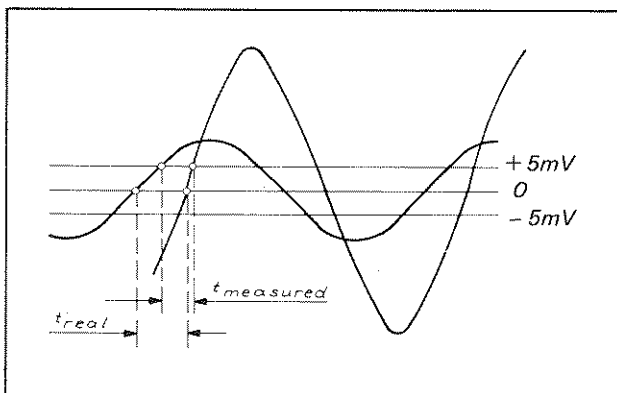

Fig. 7.17 Variation in slew rate will result in phase error.

The systematic phase error for sine waves can be expressed as:

$$\arcsin(5mV / U_{maxA}) - \arcsin(5mV / U_{maxB})$$

Since a normal time interval average measurement is made, there is also a restriction concerning minimum dead time between stop and start of the time interval (i.e. 250ns). The dead time also determines the maximum signal frequency, which is 2MHz.

Note that the PM 6654 has exactly the same performance as the PM 6652 in phase measurements.

Duty factor measurements

Duty factor (or duty cycle) measurements are similar to phase measurements. A simultaneous measurement of pulse width and period is performed. The duty factor is then calculated as:

$$\text{Duty factor} = \frac{\text{Pulse width}}{\text{Period}}$$

Fig. 7.18 illustrates the measurement.

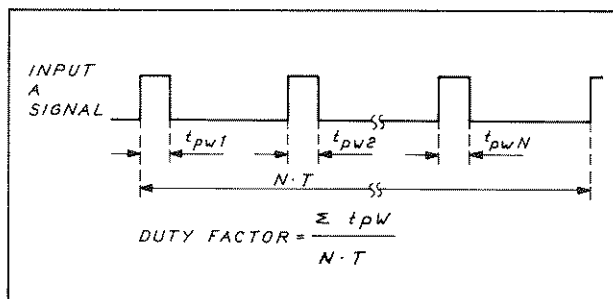

Fig. 7.18 Duty factor measurements

Voltage Measurements

Measurement of the input voltage levels V_{max} V_{min} on channel A can be performed on DC input voltages and on repetitive signals in the frequency range 100Hz...20MHz.

For input signals up to 20MHz the measurement has "voltmeter performance" (i.e. an accuracy of about 3% of the reading). Voltage measurements can be performed up to 80MHz with reduced accuracy.

SPECIAL FUNCTIONS

V_{pp} is the calculated result of a V_{min} and V_{max} measurement, which means that both functions " $V_{max} V_{min} A$ " and " $V_{pp} A$ " are the same as far as voltage measurement is concerned. The displayed result when " $V_{pp} A$ " is selected is then calculated as $V_{max} - V_{min}$.

When the shape (sine, pulse) of the input signal is known, half the crest factor can be set as the constant K in the mathematical function. The display will then show the actual V_{RMS} value of the input signal.

EXAMPLE: A sine wave has a crest factor of 0.707 ($\sqrt{2}/2$). Half the value is loaded as the MATH constant " K " = 0.354. With AC coupled inputs and with V_{pp} selected, the display will now show the RMS value of any sine wave input.

If the sine wave is superimposed on a DC voltage, the RMS value is found as: $0.354 \times V_{pp} + V_{dc}$. If V_{dc} is not known it can be found as:

$$V_{dc} = \frac{V_{max} + V_{min}}{2}$$

External Control

General

EXT CONTROL is a switch located on the rear panel. This switch allows an external signal to start or stop measurement. With ARMING the start is defined; with EXT GATE the start/stop is defined; and with AVG a number of samples is taken during the set measuring time. The start and stop of sampling is defined by the AVG control signal.

The active slope of the EXT CONTR signal can be set to NORMAL or INVERTED with the SLOPE-button*. The selection is indicated on the front panel. NORMAL-slope will be presumed in the following text.

*) Only on PM6652C, -54C.

Arming

Arming enables the counter to avoid starting on unwanted signals. The external ARMING input (input E on the rear panel) allows an additional trigger condition. When input E goes high (above 2 V), the counter is prevented from starting a new measurement. However, the counter makes all preparations for a measurement. When input E returns to low (below 0.5 V), the measurement will start with a minimum of delay. The delay is approx 50 ns; see Fig. 7.19.

NOTE: Arming cannot be used for TOT A manual mode, phase and duty factor measurements.

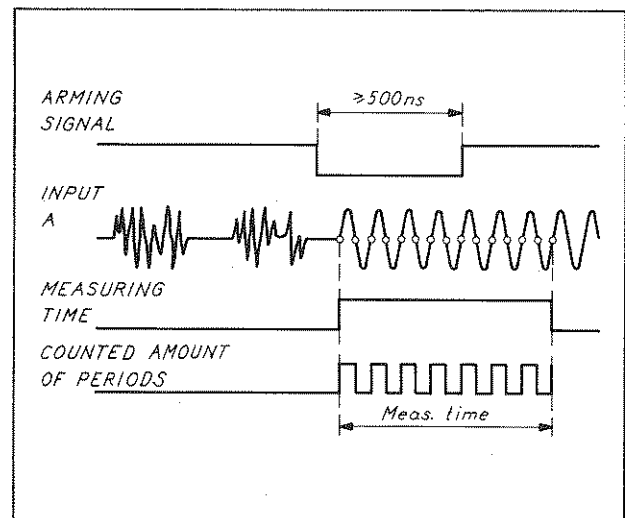

Fig. 7.19 The ARMING function.

Ext Gate

The External Gate function allows full control of the start and stop of the measurement. When EXT GATE is selected and the control input signal is low the counter makes all necessary preparations for a measurement.

On a low-to-high transition of the gate signal, measurement starts when the input signal triggers. Measurement stops on the first trigger after the gate signal goes high to low. See Fig. 7.20.

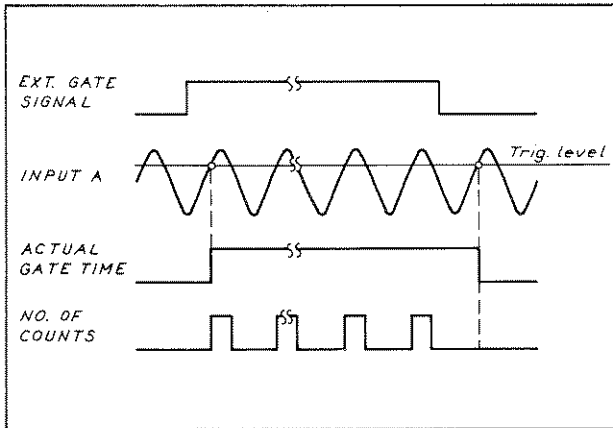

Fig. 7.20 External gate

External gate can be used in FREQ A, FREQ C and PERIOD measurements. Note that the use of EXT GATE in a PM 6652 will result in reciprocal frequency measurements for all frequencies.

Also note that the use of EXT GATE in a PM 6654 will result in the same performance as a PM 6652 (i.e. a 100ns internal clock is used and relative resolution (in 1s) is altered from 2×10^{-9} (normal PM 6654 resolution) to 10^{-7}).

Average

By using the average function it is possible to take samples of the input signal during measurement. This can be useful (when for instance, measuring the frequency in repetitive bursts; see Fig 7.21. The input frequency range is for PM 6652 channel A, 0...100MHz, for PM 6654 channel A, 0...120MHz. When the C-channel option is used 50...1500MHz for both counters.

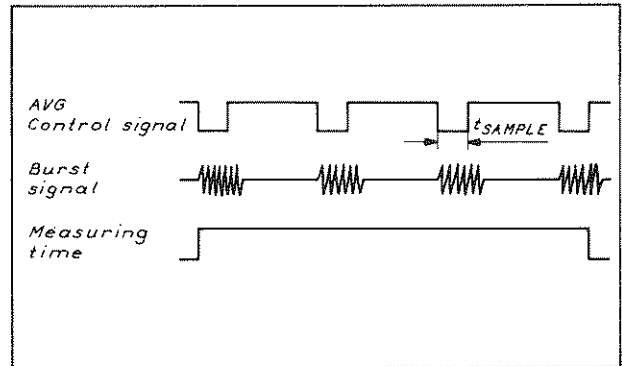

Fig. 7.21 Frequency average.

The bursts can be as short as 200ns (PM 6654) or 500ns (PM 6652). The measurement is interrupted when the ext. control input is high ($>2V$). The effective gate time is thus the sum of the "sample pulses" during the set measuring time, according to Fig. 7.21.

In order to ensure synchronization of measurement, each sample pulse must stop before the burst input stops.

In the PM 6654 the control signal (sample pulse) must go high at least 50ns before the burst stops; see Fig. 7.22.

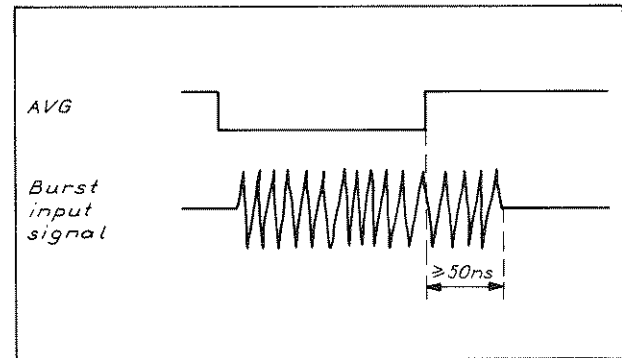

Fig. 7.22 AVG signal in the PM 6654 must go high at least 50ns before the burst stops.

In the PM 6652 the input signal must contain at least 20 cycles; 10 of these before the AVG signal goes high and then at least another 10 cycles after the low to high transition of the AVG signal; see Fig. 7.23.

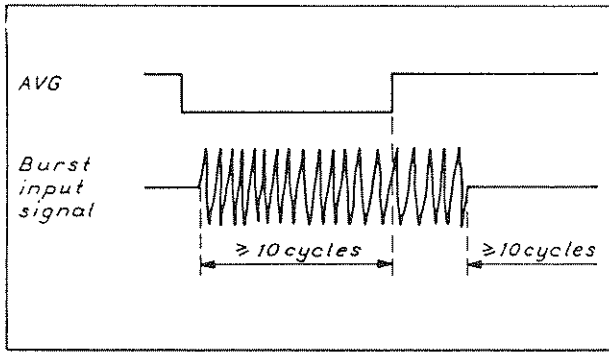

Fig. 7.23 The AVG signal in the PM 6652 must go high at least 10 input cycles before the burst stops.

The use of AVG in a PM 6652 will result in reciprocal measurements (FREQ A, FREQ C) for all frequencies.

The difference in propagation delay in the two internal channels for input event counts and clock pulses is very small; approx. 15 ns for the PM 6652 and approx 1 ns for the PM 6654. In FREQ A AVG mode with very short sample pulse times, this delay will cause a measurable error as the 1ns or 15 ns will be repeated for each external sample pulse.

It is possible, however, to compensate for this error. Measure a stable, continuous signal of approx. the same frequency, in the normal mode without external control signal (measured value = F1). Then measure the same signal with an external control signal having the same number of samples and the same sample pulse duration as will, ultimately be used (measured value = F2). To compensate for the error obtained in the frequency average mode, multiply the reading with the factor $K=F1/F2$ using the MATH function.

The total relative error for a multiple frequency average measurement in PM 6652 is approx:

$$\pm \frac{15 \text{ ns}}{t_{EC}} \pm \frac{100 \text{ ns} \pm \text{trig error}_A}{t_{EC} \times \sqrt{N}} \pm \text{rel. time-base error.}$$

The relative error in PM 6654 is approx:

$$\pm \frac{1 \text{ ns}}{t_{EC}} \pm \frac{2 \text{ ns} \pm \text{trig error}_A}{t_{EC} \times \sqrt{N}} \pm \text{rel. time-base error.}$$

Where: t_{EC} = sample time duration
 N = number of burst samples

External reset

External reset (rear panel input) provides an equivalent function to the front panel reset push button except for the LOCAL-function of the button in the PM 6652C,-54C. The counter is always reset when the input is set to high logic level (above 2 V). A new measurement can be made when input E has returned to low (below 0.5 V).

Hold-Off

The counters are equipped with trigger Hold-Off, which avoids false stop triggering on spurious or unwanted signals. The Hold-Off function is valid in all time modes (TIME A-B, PWIDTH A and RISE/FALL time A). A typical example is to suppress the effect of pulses from relay contact bounce, as illustrated in Fig. 7.24.

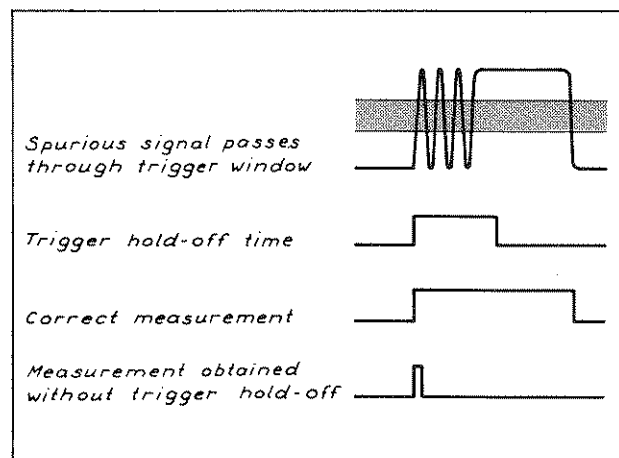

Fig. 7.24 Hold-off avoids false triggering.

Hold-Off can also be used in FREQ A and PERIOD A measurements as a digital noise suppression filter for input frequencies between 5 Hz and 150 kHz. Fig. 7.25 shows a low frequency signal with added noise.

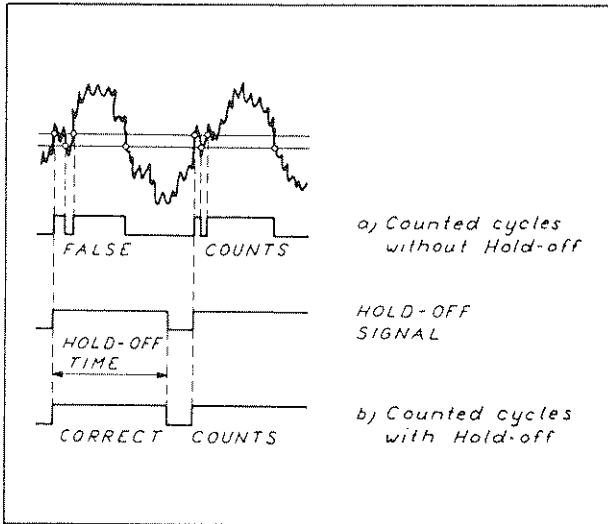

Fig. 7.25 Hold-Off as a noise rejection filter.

Without Hold-Off, the counter might trigger on the noise, thereby causing some erroneous extra counts. See Fig. 7.25.

With Hold-Off set to approx. 3/4 of the period time of the input signal, additional noise triggerings are ignored until the signal reaches its maximum negative amplitude. Retriggerring is then allowed and will occur at the beginning of the next input cycle (a new Hold-Off period starts, etc). Hold-Off is also active in the RATIO A/B and TOTALIZING A modes.

Time-Interval Delay (Programmable Hold-Off)

The PM 6654C (not the PM 6652,-54 nor PM 6652C) is capable of measuring single shot time-intervals using the Time-Interval Delay function, where the delay time can be programmed via the IEEE-488 bus.

When Time-Interval Delay is selected, the counter rejects stop-pulses for a time equal to the set **Measuring time**.

The use of the function is the same as that of Hold-Off. It is applicable to the following functions:

- Time interval A-B, single ("F6SS1")
- Single pulse width A ("F7SS1")
- Single rise/fall time A ("F9SS1")

NOTE: Time-Interval Delay cannot be selected together with Hold-Off, and it can only be programmed via the IEEE-488 bus.

Gate open

The PM 6652,-54 is equipped with a gate open output for monitoring on an oscilloscope. Fig. 7.26 is an illustration of the gate open function. Note that the gate open signal is longer than the set measuring time due to the synchronization time.

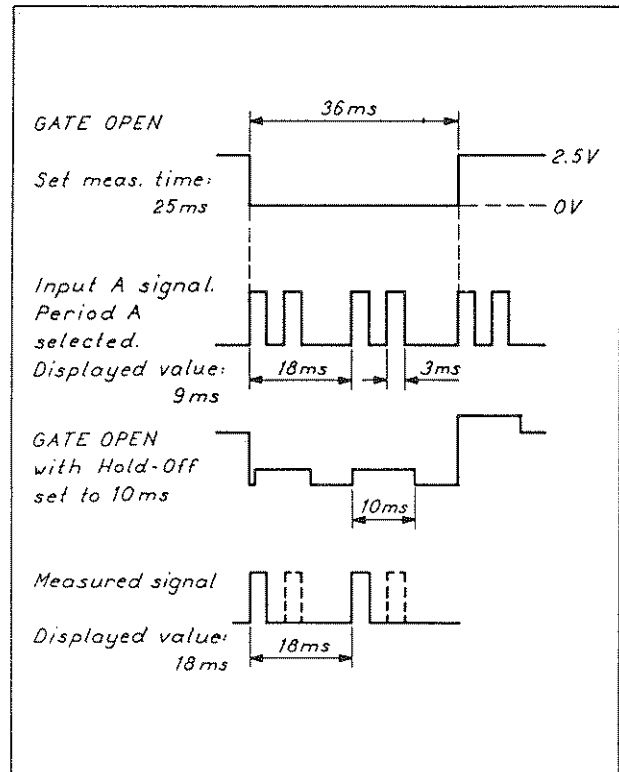

Fig. 7.26 An illustration of the gate open function, with and without Hold-Off.

Chapter 8

PERFORMANCE CHECK

CONTENTS	Page
Internal TEST programs	8-2
Front panel controls	8-3
Rear panel controls	8-4
Short form specification test	8-4
IEEE bus interface	8-7

INTERNAL TEST PROGRAMS

Both the PM 6652 and PM 6654 have built in test programs, which can be activated and monitored by the user. To activate these programs:

- Set the FUNCTION cursor to TEST.
- Press any of the keyboard buttons 1...6.

When a test is activated, the display indicates the relevant test number. When the test is completed satisfactorily, the display will return to show zeroes.

Test No.	What is tested	Duration (s)
1	Program memory	12
2	Working memory	2
3	Non-volatile memory	12
4	Measuring logic	4
5	Display	50
6	Test no 1...5 in one sequence	80

Table 8.1

Test 5 is a check of the display and all LED:s.
The test has the following sequence:

- The display shows
0000000000 EXP 0
1111111111 EXP 1
2222222222 EXP 2
3333333333 EXP 3
4444444444 EXP 4
5555555555 EXP 5
6666666666 EXP 6
7777777777 EXP 7
8888888888 EXP 8
9999999999 EXP 9

- The display shows all decimal points.

- The display shows a shifting 8 plus the "-" in front of the exponent.

- All unit indicators, function cursors and LED:s in the control buttons are lit in sequence.

- The entire display and all LED:s will light at the same time, except for the function cursor FREQ A...TEST and ST BY.

All test programs can be stopped by pressing RESET. The counter then returns to normal working mode.

If an error is detected, it is indicated by an "E" followed by the test number that failed.

The indication "E4" could be caused by incorrect setting of the INT/EXT STD IN switch on the rear panel.

In most cases, any error indication generated in a test program can be cleared by activating RESET. Measurements may be possible, but the results of any such measurement are likely to be inaccurate.

A POWER ON TEST is activated whenever power is switched from ST BY to ON. This test consists of tests numbers 2, 4 and part of number 5.

FRONT PANEL CONTROLS

START/STOP TOTALIZE A

- Select the function TOT A/MAN and check that it is possible to turn the gate indicator on and off using START/STOP TOTALIZE A.

LOCAL/RESET

- Check that the display is turned off while this control is pressed, and that it reverts to zeroes when it is released.

DISP = K x X + L

- Check that the LED can be turned on and off.

K=, L= and KEYBOARD

- Press K=. The ENTER LED should light.
- Press 1 2 3 4 5 6 7 8 9 ± EE 9 ±.
- Check that the display shows:-123456789 EXP-9.
- The ENTER LED should be blinking.
- Press ENTER. The value on the display should disappear.
- Press K= again. The display should indicate:
-123.456789 EXP-3
- Press K= again.
- Press L=.
- Check that the ENTER LED is lit.
- Press 1234.5.
- Check that the ENTER LED is blinking.
- Press ENTER and L=.
- The display should indicate 1.2345 EXP 3.
- Press L= again.

HOLD OFF

- Press HOLD OFF ON. The LED should light.
- Press READ. Now both LEDs should light.
- Adjust the potentiometer and check the display reading against table 8.2.

	Display readings	
	Potentiometer setting	
	counter-clockwise	clockwise
Pulled	$< 999 \times 10^{-6}$	$> 200 \times 10^{-3}$
Pushed	$< 5 \times 10^{-6}$	$> 1.00 \times 10^{-3}$

Table 8.2

- Press the potentiometer and switch the HOLD OFF and the READ function off.

DISPLAY HOLD

- Check that the LED can be turned on and off.

Measuring time, READ and potentiometer

- Press the READ button. The LED should light.
- Turn the potentiometer fully CCW.
- Check that the display shows 0.1 ms.
- Turn the potentiometer fully CW.
- The display should indicate 96 s.
- Switch the measuring time READ off.

MINIMUM/SINGLE

- Check that the LED can be turned on and off.

FUNCTION

- Check that the cursor can be moved through all functions and programs both stepwise and in repetitive "scrolling" mode. The cursor jumps over the C function if the option is not installed. It hesitates in position FREQ A and TEST.
- Test both pushbuttons

STORE

- Press STORE once. The LED should light.
- Press RESET. The STORE LED should be turned off. Be careful with any existing stored panel programs. Only press STORE once.

Input controls

- Check that each LED is lit and turned off by the relevant push button.

Triggering controls

- Press AUTO and check that the LED is turned on and off.
- Press KEYBOARD and leave it on (LED on).
- Press AUTO twice. Both AUTO and KEYBOARD should be turned off.
- Press READ (LED on).
- Check that both attenuators are off.
- Turn both potentiometers fully CCW.
- Check the set levels. They should be below -5.00 V.
- Repeat for the fully clockwise position, The values should be above +5.00 V.

SET A and SET B

- Press SET A. The ENTER LED should light.
- Enter 123, the display should read 1.23.
- The ENTER LED should be blinking.
- Press ENTER, the LED should go off.
- Repeat the same exercise for channel B.
- Press the KEYBOARD button.
- Press READ.
- Check that the attenuator is in position x1.
- The display should now show 1.23 and 1.23.

REAR PANEL CONTROLS

External control

- Set the switch on the rear panel to position EXT GATE.
- Check that the front indicator EXT GATE is on.
- Repeat for FREQ AVG and ARMING.
- Depress the SLOPE button.
- Check that the indicator on the front panel is on.
- Set the EXT CONTR back to off and SLOPE back to NORMAL.

EXT/INT standard

- Set the switch to position EXT STD.
- Switch the counter off and on.
- With no signal connected to the rear EXT STD input the counter should indicate error E4.
- Set the switch back to position INT.

SHORT FORM SPECIFICATION TEST

Test equipment required

- LF-Synthesizer e.g. Philips PM 5190
- Voltmeter e.g. Philips PM 2517
- Lowpass filter e.g. Philips PM 9665B
- PM 9584 50 Ohm T-piece
- 50 Ohm termination PM 9581 or PM 9585
- Oscilloscope e.g. Philips PM 3215
- HF signal generator e.g. Wavetek 2002A
- Frequency counter e.g. Philips PM 6672
- IEC-Bus controller e.g. HP 85
- Sampling oscilloscope BW min. 500 MHz

Sensitivity and frequency range, inputs A and B

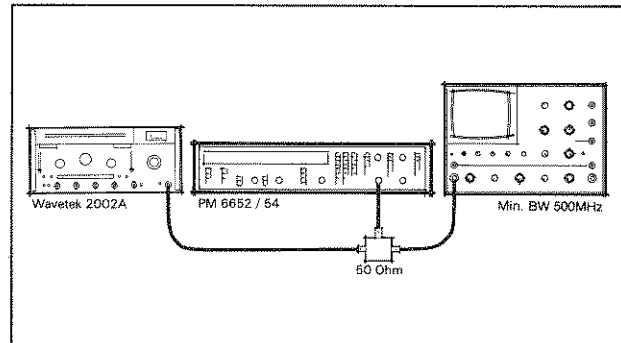

Fig. 8.1 Measuring set up.

- Switch on the counter in non programmed mode.
- Select "50 Ohm" on channel A and KEYBOARD.
- Adjust the measuring time to approx. 10 ms.
- Connect the units according to fig. 8.1.
- Set the HF generator to 60 MHz and -15 dBm.
- The oscilloscope should indicate approx. 56 mV_{pp} and the counter 60 MHz.
- Change the HF-generator to 120 MHz and -12 dBm.
- Check that the oscilloscope indicates approx. 80 mV_{pp} and the counter 120 MHz.
- Select RATIO A/B and COMMON. Change the HF-generator to 10 MHz and -17 dBm.
- The oscilloscope should indicate approx 45 mV_{pp}.
- The counter shows 1.00 E.

Sensitivity and frequency range, input C

- Select the function FREQ C.
- Connect the HF generator to input C.
- Check that the counter counts correctly from 100...1000MHz at a signal level of -27dBm.
- Check the correct counting at -17dBm signal level from 1000...1500MHz.

Check V_{max} and V_{min}

- Select the function V_{max} V_{min} , but do not connect any input signal.
- The counter should now indicate $V_{max} = 0 \pm 30mV$ and $V_{min} = 0 \pm 30mV$.
- Connect a 4.00V DC level to channel A, using a low pass filter on the input.
- The readings should be $V_{max}=4.00 \pm 0.09V$, $V_{min}=4.00 \pm 0.09V$.
- Change the DC level to 40V.
- The counter should indicate $V_{max}=40.0 \pm 1.3V$, $V_{min}=40.0 \pm 1.3V$.

- Repeat the measurement with inverted polarity.

- Connect a sinusoidal signal to channel A from the PM 5190 with an amplitude 4.00V_{pp} and a frequency of 100kHz.
- The indication should be $V_{max}=2.00 \pm 0.15V$, $V_{min}=-2.00 \pm 0.15V$.

- Change the amplitude to 18V_{pp}.
- The display should read $V_{max}=9.0 \pm 1.2V$, $V_{min}=-9.0 \pm 1.2V$

The relatively high inaccuracy is due to the specification of the generator.

Trigger indicators and controls

- Start the counter in non programmed mode.
- Connect the following signal to channel A: sinus, 10kHz, 1.0V_{pp} and +0.50V_{DC}.
- Select trigger level setting via potentiometer.
- Turn the potentiometer for channel A and verify that the three modes of the trigger indicator are working properly.
- Repeat the exercise with channel B.
- Connect the generator to channel A and check:

Trigger setting

level -200mV
DC
level +700mV
50 Ohm
level +200mV
AC, 1MOhm
x 10
level ±0V
x 1

Trigger indicator

blinking
on
blinking
off
blinking
blinking
off
blinking
blinking

- Select AC coupling on channel B and repeat the previous settings for channel B.
- Connect the signal to channel A.
- Only the trigger indicator for channel A should be blinking.
- Press common.
- Both indicators should be blinking.
- Connect the signal to channel B.
- No trigger indicator should be blinking.

Check of the Time interval function

- Switch the counter on in non programmed mode.
- Select the functions TIME A-B, KEYBOARD, COM, 50 Ohm and negative slope on channel A, measuring time approx. 10 microseconds.
- Set a LF generator to 1.5MHz and 2V_{pp}.
- Connect the generator to channel A.
- The counter should show approx. 333ns.
- Select positive slope for channel A and negative for channel B.
- The display should indicate approx. 333ns.

Rear inputs

EXT CONTR, EXT RESET and EXT STD IN

- Start the counter in a non programmed position.
- Measuring time 100ms and select CHECK.
- Ext control to ARMING.
- The counter should measure and display 10MHz.
- Connect a 1.9V DC level to the EXT control input.
- The counter should not measure (gate diode off)

- Reduce the DC level at the EXT input to 0.50 V.
- The counter should measure and display 10 MHz.
- Depress the SLOPE button so that the indicator for INVERTED is switched on.
- The counter should not measure.
- Set the rear EXT CONTR to OFF.
- Connect the DC-level of 1.9 V to EXT RESET input.
- The display should show zero.
- Reduce the EXT RESET DC level to 0.50 V.
- The counter should indicate 10 MHz.
- Set the INT/EXT STD switch to EXT STD.
- The counter should not measure.
- Connect a 10.00 MHz signal with an amplitude of 400 mV_{RMS} (terminate with 50 Ohm) to the EXT STD input.
- The counter should measure and show 10 MHz.
- Set the EXT STD switch to position INT STD.

Rear outputs

TRIGG LEVEL OUT

- Set the counter to position FREQUENCY A.
- Connect a voltmeter to TRIGG LEVEL OUT A.
- Select a trigger level via the potentiometer (KEYBOARD and AUTO off) and press READ.
- Adjust the trigger level to 5.00 V \pm 0.01 V.
- Check that the voltmeter shows 4.92...5.08 V.
- Adjust the trigger level to -5.00 V.
- Check that the voltmeter shows -5.08...-4.92 V.
- Select KEYBOARD.
- Set 5.12 V, the voltmeter should read 5.07...5.17 V.
- Set -5.11 V and check: -5.16...-5.06 V.
- Set 0 V and check: -10...+10 mV.

10 MHz OUT

- Connect an oscilloscope to the 10 MHz output. Use coaxial cable and 50 Ohm termination.
- The output voltage should be above 1.3 V_{pp}.

GATE monitor

- Switch the counter off when in non programmed mode. Switch on again.
- Select CHECK, KEYBOARD triggering and RATIO A/B.

- Turn the measuring time potentiometer fully counter clockwise.
- Connect, via a coaxial cable, an oscilloscope (no 50 Ohm termination) to the GATE monitor output.
- Switch the HOLD OFF on with the potentiometer pressed in and turned to the fully counter clockwise position. There should be a signal as in fig. 8.2, where the frequency of the superimposed pulses on the square wave is adjustable by means of the HOLD OFF.

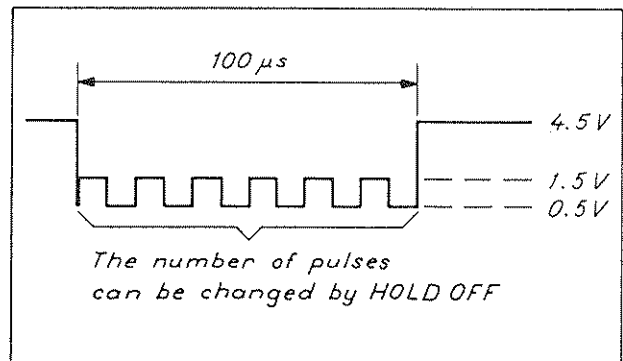

Fig. 8.2 Gate monitor pulse with HOLD OFF pressed and turned to minimum position.

IEEE BUS INTERFACE

- Connect a controller to the IEEE Bus interface PM 9696 in the PM 6652,-54.
 - Set the PM 9696 to position "talker only" off.
 - Select an address (all allowed except 31).
 - Switch on the PM 6652,-54.
 - Select measuring time 100 ms and press CHECK.
 - The counter should display 10MHz.
 - Do not change the measuring time setting during the test.

 - Via the controller, give bus command REMOTE.
 - The counter should go to remote mode, the indicator "REMOTE" should light and the measurements should continue with all front panel controls disabled.
 - From the controller, program the unit to measure PERIOD A, send the command F3 from the controller.
 - The counter should measure and display 100 ns.

 - Give bus command LOCAL.
 - The counter should go back to LOCAL mode; the remote indicator should go off.
 - Activate the DISPLAY HOLD function by pressing the control.
 - Give bus command REMOTE.
 - The counter should go over to remote, the indicator "REMOTE" should be on, all controls disabled and no measurements take place; the display shows only zeros.

 - Ask, via the controller for the status byte of the counter (serial poll).
 - The result should be 19 (decimal).

 - Give a bus TRIGGER command (GET) via the controller.
 - The counter should perform one measurement.
 - The result should be 100 ns.
 - Read the result via the controller. For a PM 6652 it should be: PA 000100.0000E-9 \pm 2 in the LSD-position. For a PM 6654 it should be: PA 00100.00000E-9 \pm 2 in the LSD-position. If the reading fails then check the set DEFAULT DELIMITER in the PM 9696.

 - The counter should not be measuring.
 - Give a bus TRIGGER command (GET) via the controller.
 - The counter should perform one measurement; check the GATE indicator.
- Give bus command SELECTIVE DEVICE CLEAR (SDC).
 - The counter should go to the FREQ A function.

 - The functions DISPLAY HOLD and CHECK should be switched off.
 - The display should only show zeros.

 - Program the CHECK function, command CH1.
 - Send the command F17 via the controller.
 - The counter should stop the measurement and give the message SERVICE REQUEST.

 - Ask, via the controller, for the status byte of the counter (serial poll).
 - The answer should be 111 (decimal).
 - The counter should start to measure and display 10 MHz.

 - Give bus command SELECTIVE DEVICE CLEAR (SDC).
 - The function CHECK shall be switched off.
 - The counter should not measure and the display should show only zeros.

 - Give bus command LOCAL.
 - The counter should go to local mode, the remote indicator goes off and all controls are activated again.

 - Give bus command REMOTE.
 - Make a quick depression of the LOCAL/RESET-button.
 - The counter should go to local mode, the remote indicator goes off and all controls are activated again.



TECHNICAL SPECIFICATION

CONTENTS	Page
Definitions	9-2
Oscillators	9-3
Measuring modes	9-4
Input specifications	9-7
Output specifications	9-8
Auxiliary functions	9-9
General	9-10
Options	9-11
Accessories	9-12

DEFINITIONS

Inaccuracy

The inaccuracy (relative error) of a measurement depends on 4 factors:

- rel. resolution
- rel. time base error (if any)
- rel. trigger error (if any)
- rel. systematic error (if any)

Inaccuracy = \pm rel.resolution \pm rel.time base error \pm rel.trigger error \pm rel.systematic error

Trigger error

Trigger error (T.E.) is the absolute measurement error due to input noise, causing triggering which is too early or too late.

FREQUENCY, PERIOD, RATIO

T.E. = \pm Noise Voltage (V_{pp})/Signal slew rate (V/s)
T.E. = $\pm 1/\text{FREQ} \times \pi \times \text{S/N-ratio}$ (sine wave)

TIME INTERVAL, RISE/FALL TIME, PULSE WIDTH, DUTY FACTOR

T.E. = \pm Noise Voltage (V_p)/slew rate at START point \pm Noise voltage (V_p)/slew rate at STOP point

PHASE

T.E. = $\pm 1/\text{FREQ} \times \pi \times \text{S/N-ratio}$ (Sine wave, same S/N-ratio for both channels)

Resolution

Multiple event measurements

FREQUENCY, PERIOD and RATIO, the resolution is the smallest increment between two measuring results. The measuring resolution is due to the ± 1 count error. After calculation, the result to be displayed is truncated to include only significant digits giving a measuring resolution

of 0.2...2 LSD units. Total resolution, including LSD resolution, is therefore 1 LSD unit (70% probability) or 2 LSD units (30% probability) but can always be reduced to 1 LSD unit by increasing the measuring time somewhat.

Single event measurements

PERIOD SINGLE and TIME INTERVAL SINGLE, resolution is one clock pulse period, regardless of the measuring time.

Statistical measurements

TIME INTERVAL AVERAGE, RISE/FALL TIME, PULSE WIDTH, PHASE and DUTY FACTOR, the resolution is the smallest increment between two measuring results with a confidence level of 95%.

Systematic error

When a systematic error is known, the measured value can be compensated before display by using the MATH functions.

TIME INTERVAL, PULSE WIDTH

Syst. error < $\pm 2\text{ns}$ (PM6654) or < $\pm 4\text{ns}$ (PM6652)

RISE/FALL TIME

Syst. error = TIME INTERVAL syst. error \pm
 $\pm \frac{2\% \text{ of } V_{pp} (A) + 5\text{mV}}{\text{slew rate (A) at } 10\% \text{ (V/s)}} \pm$
 $\pm \frac{2\% \text{ of } V_{pp} (A) + 5\text{mV}}{\text{slew rate (A) at } 90\% \text{ (V/s)}}$

PHASE (AC-coupling, trigger level = 0V)

Sine wave:

Syst.error < $\arcsin(5\text{mV}/U_{\text{max}} A) - \arcsin(5\text{mV}/U_{\text{max}} B)$

Triangular wave:

Syst. error < $\frac{5\text{mV} \times 90^\circ}{U_{\text{max}} A} - \frac{5\text{mV} \times 90^\circ}{U_{\text{max}} B}$

Synchronization modes

Conventional mode

Means that the gate time is synchronized with an integer number of clock pulses. The error is ± 1 input cycle. (Only used in the PM 6652 above 10 MHz).

Reciprocal mode

Means that the gate time is synchronized with an integer number of input cycles. The error is ± 1 clock pulse, i.e. ± 100 ns (PM 6652) or ± 2 ns (PM 6654). The use of this mode gives 7 digits (PM 6652) or 9 digits (PM 6654) resolution for a one second measuring time.

LSD displayed

Unit value of the Least Significant Digit displayed. All calculated LSDs (see section Measuring modes) should be rounded to the nearest decade before displayed (e.g. 5 ns will be 10 ns and 0.4 Hz will be 0.1 Hz) and cannot exceed the 10th digit.

Time base error

The relative time base error is the relative deviation of the clock pulse frequency from 10 MHz. Rel. time base error = $\Delta f/10$ MHz. See specification for oscillators version/01...05.

OSCILLATORS

RELATIVE FREQUENCY DEVIATION CAUSED BY:	PM 6652,-54 VERSION	/1. standard crystal oscillator	/2. PM 9678 TCXO oscillator	/3. PM 9679 oven enclosed oscillator	/4. PM 9690 oven enclosed oscillator	/5. PM 9691 oven enclosed oscillator
Ageing:	/24 h /month /year (continuous operation)	n.a. <5x10 ⁻⁷ <5x10 ⁻⁶	n.a. <1x10 ⁻⁷ <5x10 ⁻⁷	n.a. <1x10 ⁻⁷ <5x10 ⁻⁷	<1.5x10 ⁻⁹ * < 3x10 ⁻⁸ <1.5x10 ⁻⁷	<5x10 ⁻¹⁰ * <1x10 ⁻⁸ <7.5x10 ⁻⁸
Ambient temperature variation:	Range 0...+50 °C Referred to +23 °C	<1x10 ⁻⁵	<1x10 ⁻⁶	<1x10 ⁻⁷	<3x10 ⁻⁸	<5x10 ⁻⁹
Supply voltage change of ± 10 %:		<1x10 ⁻⁸	<1x10 ⁻⁹	<1x10 ⁻⁹	<5x10 ⁻¹⁰	<5x10 ⁻¹⁰
WARMING-UP TIME: To reach a maximum deviation of 1x10 ⁻⁷ from final value		n.a.	n.a.	<10 min	<15 min	<15 min

* After 48 hours of continuous operation.

n.a. Not Applicable

PM 6652 MEASURING FUNCTIONS

FREQUENCY A

Range: 0.1 Hz...120 MHz. (0.01 Hz...200 kHz when Hold Off is selected) Typically 0.1 Hz...160 MHz at 50 mV sensitivity.

Mode: Conventional above 10 MHz. Reciprocal below 10 MHz and when Hold Off EXT GATE or AVERAGE is selected.

LSD displayed: $\frac{2.5 \times 10^{-7} \text{ s} \times \text{FREQ}}{\text{measuring time}}$ (reciprocal)
 $\frac{2.5}{\text{measuring time}}$ (conventional)

Resolution: 1 or 2 LSD units

Inaccuracy: $\frac{\text{resolution}}{\text{FREQ}} \pm \frac{\text{trigger error}}{\text{measuring time}} \pm \text{time base error}$

Signal mode: CW, SINGLE BURST, MULTIPLE BURST AVERAGE

Ext controls: EXT GATE, AVERAGE, ARMING

TIME INTERVAL A-B, PULSE WIDTH A, RISE/FALL A; SINGLE

Range: 100 ns...10¹⁰ s

LSD displayed: 100 ns (TIME below 10³ s)
 $5 \times \text{TIME}$ (TIME above 10³ s)

Resolution: $\frac{10^{10}}{1 \text{ LSD unit}}$

Inaccuracy: $\frac{\text{resolution}}{\text{TIME}} \pm \frac{\text{trigger error}}{\text{TIME}} \pm \text{time base error}$

Minimum amplitude: RISE/FALL TIME measurements: 500 mV_{pp}. If any part of the signal is above +5 V or below -5 V, then: min. amplitude = 5 V_{pp}

Ext controls: ARMING

FREQUENCY C Optional

Range: 100 MHz...1.5 GHz
 Typically ...1.6 GHz

Mode: Conventional. (Recipr. when EXT. GATE and FREQ AVG is selected.)

LSD displayed: $\frac{40}{\text{measuring time}}$ (conventional)
 $\frac{2.5 \times 10^{-7} \text{ s} \times \text{FREQ}}{\text{measuring time}}$ (reciprocal)

Resolution: 1 or 2 LSD units

Inaccuracy: $\frac{\text{resolution}}{\text{FREQ}} \pm \text{time base error}$

Signal mode: CW, SINGLE BURST, MULTIPLE BURST AVERAGE

EXT controls: EXT GATE, AVERAGE, ARMING

TIME INTERVAL A-B, PULSE WIDTH A, RISE/FALL A; AVERAGED

Range: TIME INTERVAL 0 ns...100 s
 PULSE WIDTH 4 ns...100 s
 RISE/FALL TIME 10 ns..100 s

LSD displayed: $\frac{2.5 \times 10^{-8} \text{ s}}{\sqrt{N}}$

Resolution: $\frac{100 \text{ ns}}{\sqrt{N}}$ or 1 LSD unit, whichever is greatest

Inaccuracy: $\frac{\text{resolution}}{\text{TIME}} \pm \frac{\text{trigger error}}{\sqrt{N} \times \text{TIME}} \pm \text{time base error} \pm \frac{\text{syst. error}}{\text{TIME}}$

Min dead time stop to start: 250 ns

Number of samples averaged: $\frac{\text{measuring time}}{\text{pulse repetition time}}$

Minimum amplitude: RISE/FALL TIME 500 mV_{pp}, if any part of the signal is above +5 V or below -5 V, then min. amplitude=5 V_{pp}

Ext controls: AVERAGE, ARMING

PERIOD A

Range: 100 ns...100 s (average)
 100 ns...10¹⁰ s (single)

LSD displayed: $\frac{2.5 \times 10^{-7} \text{ s} \times \text{PERIOD}}{\text{measuring time}}$

Resolution: 1 or 2 LSD units. LSD and resolution is 100 ns when single period is selected

Inaccuracy: $\frac{\text{resolution}}{\text{PERIOD}} \pm \frac{\text{trigger error}}{\text{measuring time}} \pm \text{time base error}$

No. of cycles averaged: $\frac{\text{measuring time}}{\text{PERIOD}}$ or a single period

Ext controls: EXT GATE, AVERAGE, ARMING

NOTE: EXT. CONTROL setting "AWG" results in an internal delay time of 40 ms. The range is then approx.: 40 ns...100 s.

PM 6654 MEASURING FUNCTIONS

FREQUENCY A

Range:	0.01 Hz...120 MHz. (0.01 Hz...200 kHz when Hold Off is selected) Typically 0.1 Hz...160 MHz at 50 mV sensitivity.
Mode:	Reciprocal
LSD displayed:	$5 \times 10^{-9} \text{ s} \times \text{FREQ}$ measuring time When HOLD-OFF or EXT GATE is selected, see spec. for PM 6652
Resolution:	1 or 2 LSD units
Inaccuracy:	$\frac{\text{resolution}}{\text{FREQ}} \pm \frac{\text{trigger error}}{\text{measuring time}} \pm \text{time base error}$
Signal mode:	CW, SINGLE BURST, MULTIPLE BURST AVERAGE
Ext controls:	EXT GATE, AVERAGE, ARMING

FREQUENCY C Optional

Range:	100 MHz...1.5 GHz
Mode:	Reciprocal
LSD displayed:	$5 \times 10^{-9} \text{ s} \times \text{FREQ}$ measuring time When EXT GATE is selected, see specification for PM 6652
Resolution:	1 or 2 LSD units
Inaccuracy:	$\frac{\text{resolution}}{\text{FREQ}} \pm \text{time base error}$
Signal mode:	CW, SINGLE BURST, MULTIPLE BURST AVERAGE
Ext controls:	EXT GATE, AVERAGE, ARMING

PERIOD A

Range:	8ns...100 s (average) 100ns...10 ¹⁰ s (single)
LSD displayed:	$5 \times 10^{-9} \text{ s} \times \text{PERIOD}$ measuring time When Hold Off or EXT GATE is selected see PM 6652 specification
Resolution:	1 or 2 LSD units, LSD is 1 ns and resolution 2 ns, when single period is selected
Inaccuracy:	$\frac{\text{resolution}}{\text{PERIOD}} \pm \frac{\text{trigger error}}{\text{measuring time}} \pm \text{time base error}$
No. of cycles averaged:	$\frac{\text{measuring time}}{\text{PERIOD}}$ or a single period
Ext controls:	EXT GATE, AVERAGE, ARMING

TIME INTERVAL A-B, PULSE WIDTH A, RISE/FALL A; SINGLE

Range:	8 ns...100 s
LSD displayed:	1 ns (TIME below 10 s) $\frac{5 \times \text{TIME}}{10^{10}}$ (TIME above 10 s)
Resolution:	2 ns (TIME below 10 s) 1 LSD unit (TIME above 10 s)
Inaccuracy:	$\frac{\text{resolution}}{\text{TIME}} \pm \frac{\text{trigger error}}{\text{TIME}} \pm \text{time base error} \pm \frac{\text{syst. error}}{\text{TIME}}$
Minimum amplitude:	RISE/FALL TIME measurements: 500 mV _{pp} . If any part of the signal is above +5 V or below -5 V, then: min. amplitude = 5 V _{pp}
Ext controls:	ARMING

NOTE: When Hold Off is selected, see PM 6652 specification

TIME INTERVAL A-B, PULSE WIDTH A, RISE/FALL A; AVERAGED

Range:	TIME INTERVAL 0 ns...100 s PULSE WIDTH 4 ns...100 s RISE/FALL TIME 8 ns...100 s
LSD displayed:	$\frac{2.5 \times 10^{-9} \text{ s}}{\sqrt{N}}$
Resolution:	$\frac{10 \text{ ns}}{\sqrt{N}}$ or 1 LSD unit, whichever is greatest
Inaccuracy:	$\frac{\text{resolution}}{\text{TIME}} \pm \frac{\text{trigger error}}{\sqrt{N} \times \text{TIME}} \pm \text{time base error} \pm \frac{\text{syst. error}}{\text{TIME}}$
Min dead time stop to start:	50 ns
Number of samples averaged:	$\frac{\text{measuring time}}{\text{pulse repetition time}}$
Minimum amplitude:	RISE/FALL TIME 500 mV _{pp} , if any part of the signal is above +5 V or below -5 V, then minimum amplitude = 5 V _{pp}
Ext controls:	AVERAGE, ARMING

NOTE: When Hold Off or AVERAGE is selected, see PM 6652 specification

PM 6652 and PM 6654 MEASURING FUNCTIONS

DUTY FACTOR A

Range: 0...(1 - 250 ns x Pulse rep. rate)
 Example: 0...0.9999 at 50 Hz
 0...0.9997 at 1 kHz
 0...0.5 at 2 MHz

Range: 0.03 Hz...2 MHz

LSD displ.: $\frac{2.5 \times 10^{-7} \text{ s}}{\text{measuring time}}$

Resolution: 100 ns x pulse rep. rate / \sqrt{N} or 1 LSD unit, whichever is greatest

Inaccuracy: $\frac{4 \text{ ns} \times \text{FREQ} \pm \text{resolution} \pm \text{trigg error}}{\sqrt{N} \times \text{PULSE WIDTH} \times \text{DUTY FACTOR}}$

Cycles avg.: Measuring time x pulse rep. rate

Ext controls: None

PHASE A-B

Range: 0...360° x (1 - 250 ns x FREQ).
 Example: 0...360° at 50 Hz
 0...359.9° at 1 kHz
 0...180° at 2 MHz

Range: 0.03 Hz...2 MHz

LSD displ.: 1° measuring time below 180 μ s
 0.1° measuring time 180 μ s..1.8 ms
 0.01° measuring time above 1.8 ms

Resolution: 1 LSD unit

Cycles avg.: Measuring time x FREQ A

Input voltage: 100mV...3.5V / 1V...35V (RMS sine)

Inaccuracy: $\frac{4 \text{ ns} \times 360^\circ \times \text{FREQ} \pm \text{Resolution}}{\text{PHASE} \times \text{FREQ} \times 360^\circ \times \text{trigger error} \pm \sqrt{N} \times \text{PHASE}} \pm \frac{\text{systematic error}}{\text{PHASE}}$

Ext controls: None

Vmax, Vmin, Vpp A

Range: -50 V...+50 V; DC and 100Hz...80MHz

LSD displayed: 10 mV for signals within ± 5 V
 100 mV for signals outside ± 5 V

Resolution: 1 LSD unit

Typical in-accuracy: DC, 20 mV $\pm 2\%$ of reading
 100Hz..20MHz Input signal outside ± 5 V:
 200 mV $\pm 3\%$ of reading

20...80 MHz (50 Ohm) Input signal within ± 5 V:
 20 mV $\pm 6\%$ of reading

Input signal outside ± 5 V:
 200 mV $\pm 7\%$ of reading

Vpp displayed: The result of simultaneous V_{max} and V_{min} measurements

High freq. error: Above 80 MHz (50 ohm) or above 20 MHz (1 Mohm), the deviation is typically ± 3 dB

Ext controls: None

RATIO A/B

Range: 10⁻⁹...10¹⁰

Freq. range: 0.1 Hz...120 MHz/0.01 Hz...10 MHz and 0.01 Hz...200 kHz/0.01 Hz...10 MHz when Hold Off is selected)

LSD displ.: $\frac{2.5 \times \text{RATIO}}{\text{measuring time} \times \text{FREQ A}}$

Resolution: 1 or 2 LSD units

Inaccuracy: $\frac{\text{resolution} \pm \text{trigg error B}}{\text{RATIO} \times \text{measuring time}}$

Ext controls: ARMING

RATIO C/B

Range: 10¹...10¹¹

Freq. range: 100 MHz...1.5 GHz/0.01 Hz...10 MHz

LSD displ.: $\frac{40 \times \text{RATIO}}{\text{measuring time} \times \text{FREQ C}}$

Resolution: 1 or 2 LSD units

Inaccuracy: $\frac{\text{resolution} \pm \text{trigger error B}}{\text{RATIO} \times \text{measuring time}}$

Ext controls: ARMING

TOTALIZE A

Range: 1...10¹⁸

Freq. range: 0...120 MHz and 0.01 Hz...200 kHz when Hold Off is selected

Pulse pair resolution: 8 ns

Manual mode: Controlled by pushbutton START/STOP

Ext. mode: Totalizing on A during pulse duration on B or between start/stop pulses on B

Min. Pulse-width B: 40 ns

Inaccuracy: $\frac{\text{pulse rep rate A} \times \text{trigger error B}}{\text{total counts}}$

Ext controls: ARMING (not valid in manual mode)

INPUT SPECIFICATIONS

Inputs A and B

Freq. range: DC coupled: 0...160 MHz
 AC coupled: 20 Hz...160 MHz

Rise time: approximately 1 ns

Sensitivity:
 - 0...60 MHz: 20 mV_{RMS} or 60 mV_{pp}
 - 60...120 MHz: 30 mV_{RMS} or 90 mV_{pp}
 - 120...160 MHz: 50 mV_{RMS} or 140 mV_{pp}(typ.)

Pulse width: Minimum 4 ns

Attenuation: x1 x10 (fixed)

Hysteresis: approx 40 mV_{pp}. Hysteresis compensation is automatically performed in TIME A-B, P Width A, RISE/FALL-A, PHASE A-B and DUTY FACTOR measuring modes; resulting in a residual hysteresis band which is virtually 10 mV_{pp}

Dynamic input voltage range: 60 mV_{pp}...5 V_{pp} within ±5 V_{DC} x1
 600mV_{pp}...50V_{pp} within ±50V_{DC} x10

Trigg. level selection: Manually via keyboard (10mV steps),
 Manually via potentiometers,
 Auto trigger.

Trigger level range: -5 V...+5 V (x1)
 -50 V...+50 V (x10)

Trigger level setting accuracy: ±10 mV ±1 % of set value.

Trigg. slope: Positive or negative

Trigger level output: Set trigger levels for channel A and B, -5 V...+5 V, available at rear panel (BNC-connectors).

Trigger level read-out: Set trigger levels for channel A and B are displayed with a resolution of 10 mV (x1) or 100 mV (x10)

Trigger indicators: Three state LED indication:
 On: Signal is above the set trigger level
 Blinking: Triggering occurs
 Off: Signal is below the set trigger level

AUTO trigger: The AUTO trigger will automatically set A and B trigger levels to 50 % of input signal amplitude (10 % and 90 % for RISE/FALL TIME measurements). The frequency range is 100 Hz...120 MHz. The measuring cycle time is approximately 300 ms plus the measuring time.

Coupling: DC/AC

Channel input: Separate A and B or common via A

Impedance: Separate A and B 1 MΩ//35 pF nominal or 50 Ω nominal (A and B)
 Common A 0.5 MΩ//70 pF nominal or 50 Ω (A) open input (B)

Max. input voltage: 1 MΩ x1: 260 V_{RMS} up to 20 kHz declining to 12 V_{RMS} at 1 MHz
 1 MΩ x10: 260 V_{RMS} up to 20 kHz declining to 100 V_{RMS} at 1 MHz and to 25 V_{RMS} at 120 MHz
 50 Ω 12 V_{RMS} DC...120 MHz

Input C

Freq. range: 100 MHz...1.5 GHz.

Input voltage range: 10 mV_{RMS}...12 V_{RMS} from 100 MHz to 1 GHz, 30 mV_{RMS}...12 V_{RMS} from 1 GHz to 1.5 GHz.

Coupling: AC

Impedance: 50 Ω nominal; VSWR below 2.

AM tolerance: 98 %; minimum signal must exceed minimum operating input voltage

Max. input: 12 V_{RMS}. Overload protection with PIN diodes.

Input D (ext. standard in)

Range: 100 kHz...10 MHz

Coupling: AC

Impedance: 1.5 kΩ nominal

Sensitivity: 400 mV_{RMS}

Max input: 25 V_{RMS}

NOTE: As external reference frequency, only 10 MHz will give correct decimal point and unit indication. With the optional frequency multiplier PM 9697 references of 1 and 5 MHz can also be accepted.

NOTE: Auto trigger requires a repetitive signal. The input signal may have any duty factor.

Input F (ext. reset)

Electrical reset, equivalent to front panel RESET pushbutton. Counter is reset when input F is high. A new measurement can be made after input F has returned low. The measurement will start after a delay of approx. 50 ms to 100 ms (depending on selected function) plus time needed for synchronization with the input signal.

High level: Above 2 V
Low level: Below 0.5 V
Impedance: 2 kOhm (typical)
Max. input: ± 25 V
Min. pulse duration: 50 ns

Input E (arming, ext. gate, average)

SLOPE: The active slope of the INPUT E signal can be changed (inverted) by pushing the SLOPE button. (PM 6652C, -54C only). The NORMAL (default) setting gives the functions described below.

A 4-position rear panel switch gives choice of external control of the counter.

OFF: No function selected.
ARMING: The counter is prevented from starting a new measurement when input E is high. A high-to-low transition (normal slope) arms the counter to start a new measurement. Arming is not applicable in TOT A (manual), PHASE and DUTY FACTOR measurements.

AVERAGE: Frequency (channel A or C), period A and time interval A-B measurements are interrupted when input E is high (normal slope). The measurement is continued again when input E is low.

EXT GATE: The signal on input E defines start and stop of the measuring time and overrides the set MEASURING TIME. When input E goes high (normal slope), the measurement will start after a synchronization delay. The measurement will stop when input E returns low, after a synchronization delay.

High level: Above 2 V
Low level: Below 0.5 V
Impedance: 2 kOhm nominal
Max. input: ± 25 V
Int. delay: approx. 50 ns.

Minimum pulse duration:

- Arming: 200 ns
- Ext. gate: 500 ns
- Average: PM 6652: 500 ns and PM 6654: 200 ns

OUTPUT SPECIFICATIONS

Output G (10 MHz out)

Output freq.: 10 MHz
Output level: $> 1.3 V_{pp}$ into a 50 Ohm load
Protection: Short circuit proof

Output H (gate open)

The gate status output allows monitoring on an oscilloscope of the actual measuring time and the trigger Hold Off time.

Gate closed: 4.5 V output level (typical)
Gate open: 0 V output level (typical)
Hold Off time: 1.2 V output level (typical)
Output impeded: 1.5 kOhm (typical)
Internal delay: 150 ns (typical)
Protection: Short circuit proof

Outputs I and J (trigg level out)

Buffered output for set trigger levels on channels A and B. The range is $-5 V \dots +5 V$ unaffected by the input attenuator setting (x1 or x10). These can be used as two independent bus programmable DAC.

Output levels: $-5 V \dots +5 V$
Impedance: 2 kOhm (typical)
Protection: Short circuit proof
Nonlinearity: less than ± 10 mV
DC-offset: less than ± 7 mV
Settling time: less than 1 ms

AUXILIARY FUNCTIONS

Measuring time/Display time

Setting of the measuring time can be made in three different ways:

1 Variable

The measuring time is continuously variable, 0.1 ms...96 s, with clear setpoints at 0.1 ms, 1 ms, 10 ms, 0.1 s, 1 s, 10 s, and 96 s. Selected variable measuring time is displayed, without any delay, when depressing the measuring time "READ" push button.

2 MINIMUM SINGLE

With MINIMUM/SINGLE activated the counter will perform single event measurements for: PERIOD A, RATIO A/B, RATIO C/B, TIME A-B, P WIDTH A and RISE/FALL A.

A minimum measuring time of approximately 2 μ s is performed for FREQ A, FREQ C in PM 6654.

A minimum measuring time of approximately 1 μ s is performed for FREQ A, FREQ C in PM 6652 and for PHASE A-B and DUTY FACTOR A in both PM 6652 and PM 6654.

The variable MEASURING TIME/DISPLAY TIME control will now act only as display time control. The measured result is displayed during the set display time and a new measurement will start at the next input signal. The MINIMUM/SINGLE function is useful for measurements of single-shot phenomena and measurements of signals present during a short time, e.g. single burst frequency.

3 EXT.GATE

The use of EXT. GATE (see INPUT E specification) will override the set measuring time. The external gate duration must be in the range 500 μ s...96 s. The resolution is always 100 ns, i.e. a PM 6654 will have the same specification as a PM 6652.

Actual measuring time

The actual measuring time equals the selected measuring time (whether being set continuously via MINIMUM/SINGLE or via EXT GATE) plus the

time needed to synchronize the measurement with an integer number of cycles of the input signal, for all reciprocal measurements.

DISPLAY HOLD

Depressing the DISP HOLD pushbutton sets display time to infinity and freezes the last measurement result. A new measurement can be initiated using RESET.

Hold-off

With trigger Hold Off activated the counter ignores retriggering (channel A) or stop triggering (channel B) during the set Hold Off time.

The Hold Off function is applicable in all channel A measuring modes and also on channel B in the TIME A-B mode. The Hold Off function can be used as a low-pass filter with variable cut-off frequency between 5 Hz...150 kHz for FREQUENCY and PERIOD measurements.

Range:	5 μ s...200 ms or 0 (off)
Read-out:	The Hold Off time is measured and displayed by pressing the read button
Monitor:	The set Hold Off duration is visible via the gate open output

NOTE: When Hold Off is active, the frequency range for period and frequency measurements is limited to 0.01 Hz...200 kHz (PM 6652 and PM 6654) and clock resolution in all measuring modes will always be 100 ns (PM 6654).

Time interval delay (programmable hold-off)

(Only the PM 6654C)

When Time Interval Delay is activated, the counter disables stop-pulses (Hold Off) for a time equal to the set **Measuring time**.

Range:	100 μ s...99 s.
Accuracy:	$\pm 25 \mu$ s ± 1 % of set value.
Applicable functions:	Single time interval A-B Single pulse width A Single rise/fall time A

NOTE: Hold Off cannot be selected at the same time as Time Interval Delay. Time interval delay is only accessible via the IEEE-488 bus.

Mathematics

The mathematical functions of PM 6652,-54 makes it possible to offset a measuring value or to change scale factor (normalizing).

The offset facility allows adding or subtracting a reference value to the measured value before display, e.g. measurement of tuned receiver frequency, by measuring the local oscillator frequency (IF-offset).

The scaling facility allows multiplying of the measured value by a constant before display, e.g. conversion of frequency to RPM. The scaling and offset features may be combined, so that the displayed value equals $K \times X + L$. X is the measured value and K and L are constants. Mathematics cannot be applied to the function V_{max} , V_{min} .

Check

10 MHz internal reference is connected to the counting logic of input channels A and B. Self-test of most measuring functions can be selected.

Reset

Manual via pushbutton or electrical via input F. Reset will clear keyboard entry, status, an active STORE state, and/or start a new measurement.

Power on/Stand by

In "ST BY" position, power is available to maintain an ovenized crystal oscillator.

Test function

The counter performs a choice of 5 self test routines of the logic and computing functions. The functions tested are: ROM (No.1), RAM (No.2), EAROM (No.3), measuring logic (No.4) and display (No.5). Test No.6 when selected will perform all tests 1...5 in a sequence. At power-up a limited test sequence is performed.

Programs P1...P8

Eight front panel "menus" can be stored in and recalled from a non-volatile memory. All front- and rear panel settings can be stored, except Hold Off value (but status of pushbutton "Hold Off on/off" is stored). Programs P7 and P8 can not store the mathematical functions.

GENERAL

Display

Read out:	10 digits, sign and exponent (11 mm high-efficiency LED)
Unit indicators:	3 LEDs indicating Hz, s or V. Any prefix (kHz, μ s) is indicated by the exponent on the display.
Gate lamp:	Indicates that main-gate is opened and measurement takes place.
ST BY:	Stand-by indication with LED when instrument is not switched ON.
REMOTE:	Indicates that the counter is remotely controlled via the BUS interface option (IEC-625/IEEE-488).
ARMED/FREQ	Indicates position of rear panel EXT CONTROL switch (LOCAL mode) or programmed setting of EXT CONTROL function (REMOTE mode)
INV EX CON	Indicates active slope of INPUT E
Cursor:	Indicates selected measuring function and/or selected front panel menu (Programs 1...P8).

Power requirements

In addition to the normal line voltage supply, the PM 6652 and PM 6654 can also be powered by an external DC voltage.

Line:	115/230 V \pm 15%; 45...440 Hz below 60VA.
DC source:	Voltage 17..29 V; max 2 A at 24 V.
Line interference:	Below VDE 0871 B and MIL STD 461.
Safety:	Accord. to IEC 348 and CSA 556B.

Dimensions and weight

Width:	440 mm (excluding 19" brackets)
Height:	89 mm
Depth:	440 mm
Weight:	Net: 8 kg. Shipping: approx. 10 kg

Environmental conditions

Ambient temperature

Storage and transport: $-40^{\circ}\text{C} \dots +70^{\circ}\text{C}$.

Rated range: $-5^{\circ}\text{C} \dots +50^{\circ}\text{C}$. To allow air convection, at least 2 cm free space is required above and below the counter. Without any free air space around the counter (tightly packed 19 inch racks), the built-in fan option PM 9612 is necessary at ambient temperatures above 40°C .

Humidity: 10...90 % RH, no condensation
Storage: 5...95 % RH.

Altitude/
Barometric pressure: Operating: 53.3 kN/m^2 , 5000 m
(15000 ft).
Storage: 15.2 kN/m^2 , 15000 m
(50000 ft).

Vibration test: According to IEC 68 Fc.

Bump test: According to IEC 68 Eb.

Handling test: According to IEC 68 Ec.

Transp. test: According to NLN-L88.

OPTIONS

In the PM 6652,-54 several options can be used, the specification for some of these are described previously in this manual, i.e. different crystal oscillators, the IEEE bus interface and the 1.5 GHz Input-C.

This section will describe the analog recorder output PM 9695 and the external reference frequency multiplier PM 9697.

Analog recorder output PM 9695

The digital-to-analog converter PM 9695 provides a high resolution analog output e.g. for recording frequency stabilities of oscillators, filters and crystals on a strip chart recorder. In frequency control systems having analog feedback, the DAC serves as an accurate frequency-voltage converter. The PM 9695 permits conversion of any three consecutive digits; as such it functions as a magnifying class to focus on the most important part of the read-out.

Decade

Conversion: Any three consecutive digits can be selected. The value of the least significant of the 3 digits can be selected with a 12 position switch.

LSD range: $10^{-13} \dots 10^{-2}(\text{s})$ or $10^{-4} \dots 10^7(\text{Hz}, \text{V}, \text{degrees}, \text{counts or ratio})$.

Normal mode: Analog output is directly proportional to digital input. 000 produces 0.000 V and 999 produces 0.999 V.

Offset mode: Adds 500 to digital input to obtain half scale offset. 500 produces 0.000 V and 499 produces 0.999 V.

Output: Zero output 0 V
Full scale deflection 0.999 V
Impedance 100 Ohm \pm 1%
Connector BNC

Accuracy: $\pm 2\text{ mV}$

Nonlinearity: $\pm 0.5\text{ mV}$

Delay: Output voltage settling time max 100 ms after end of measurement.

Temp coeff.: $\pm(0.1\text{ mV}+0.03\% \text{ of reading})/^{\circ}\text{C}$

External reference frequency multiplier PM 9697

To accept external reference frequencies other than 10 MHz, the frequency multiplier PM 9697 can be used.

With this option installed, the PM 6652 or PM 6654 can accept external reference frequencies of 1 MHz, 5 MHz or 10 MHz. All other input specifications as for "Input D".

ACCESSORIES

Supplied with the instrument

- Mains cable.
- Fuses 0.4 A and 0.8 A.
- Two adapter with screws M6 for 19"-rack.
- Operating Manual.
- Pocket Guide. (Only supplied with instruments with IEEE-488 bus interface.

To be ordered separately

- MATE/CIIL Interface, acc. to Mate System Control Interface Standard (No. 2806763).
- PM 9610: 1,5 GHz option (Input-C).
- PM 9611: Built-in rear panel wiring option.
- PM 9612: Built-in fan option.
- PM 9613: Rack-mount slide kit.
- PM 9614: Training course set incl.:
- Cassette tape for HP 85 controller
 - Pocket guide for PM 6652,-54.
 - Text book, (can be ordered separately: order No. 9498 465 01011)
- PM 9665B: Low pass filter, 50 kHz.
- PM 9678: TCXO oscillator (version/.2.).
- PM 9679: Oven encl. oscillator (version/.3.).
- PM 9690: Oven encl. oscillator (version/.4.).
- PM 9691: Oven encl. oscillator (version/.5.).
- PM 9695: Analog recorder output (DAC).
- PM 9696B: IEEE-488 bus interface.
- PM 9697: External reference frequency multiplier.
- PM 2296/50: IEEE/IEC adapter.
- PM 2295/05: IEEE-cable (length 0.5 m).
- PM 2295/10: IEEE-cable (length 1 m).
- PM 2295/20: IEEE-cable (length 2 m).
- PM 9581: 50 Ohm feed-through termination 3W.
- PM 9585: 50 Ohm feed-through termination 1W.
- PM 8922: 120 MHz 1 MOhm probe 1:1 and 1:10.
- PM 9639: 1.5 GHz 500 Ohm probe 1:10.
- PM 8943: 650 MHz 50 Ohm/1 MOhm FET probe.

All options but the following are customer retro-fittable:

MATE/CIIL-interface, PM 9611 and PM 9612.

The multiplier PM 9697 can be installed only in the /.1.-version (standard oscillator).

The counters can only be equipped with one of the following options at a time: CIIL interface, Analog Recorder Output or IEEE-488 interface.

There are several versions of the IEEE-488 bus interface;

Timer/Counter	suitable bus interface
PM 6652,-54	PM 9696B and PM 9696
PM 6652C,-54C	PM 9696B and 'PM 9696 RTL update'

PM 6652 and PM 6654C versions and options

The ordering number consists of the basic type number and a 3 digit XYZ suffix, specifying the required customer version.

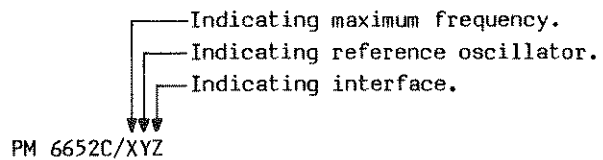

Type-No.	Description
PM 6652C/011	Programmable high resolution timer/counter, 120 MHz basic frequency range, 100 ns single shot resolution, standard oscillator 5×10^{-7} /month, incl. 19" rack mount brackets, excl. IEEE-488 bus interface.
PM 6654C/011	Idem, but with 2 ns single shot resolution.
/5..	including 1,5 GHz input channel PM 9610.
/.2.	including PM 9678 TCXO.
/.3.	including PM 9679 Oven-Oscillator.
/.4.	including PM 9690 Oven-Oscillator.
/.5.	including PM 9691 Oven-Oscillator.
/.8.	including standard oscillator and external reference frequency multiplier PM 9697.
/...2	Blind panel version including IEEE-488 bus interface PM 9696B.
/...5	normal panel version including analog recorder output PM 9695.
/...6	Normal panel version including IEEE-488 bus interface PM 9696B.
/...7	Normal panel version including MATE/CIIL interface.

Chapter 10

ADDENDUM

ADDENDUM

Introduction

The PM 6652C and PM 6654C are now available with two different HF-inputs, the 1.5 GHz input PM 9610 and the 2.3 GHz input PM 9619. This addendum describes the differences between the 1.5 GHz version described in the manual and the new 2.3 GHz version. It also describes how to identify which input that is fitted in your instrument.

Identification

Read the text on the strip at the top of the front panel edging. Strips like the one below indicate standard instruments without HF-inputs:

programmable high resolution timer/counter 120MHz

PHILIPS

The strip below is fitted on instruments equipped with factory installed PM 9610 1.5 GHz HF-inputs:

programmable high resolution timer/counter 120MHz / 1.5GHz

PHILIPS

Strips like the one below are fitted on instruments equipped with factory installed PM 9619 2.3 GHz HF-inputs:

programmable high resolution timer/counter 120MHz / 2.3GHz

PHILIPS

Adhesive labels indicating the frequency range should be fitted on the strips of instruments upgraded with HF-inputs. If the Timer/Counter is upgraded with a PM 9610, the strip with the label fitted should look like the one below. The label is included in the PM 9610 option:

programmable high resolution timer/counter 120MHz 0.1-1.5GHz

PHILIPS

If the Timer/Counter is upgraded with a PM 9619 the strip with fitted label should look like the one below. The label is included in the PM 9619 option:

programmable high resolution timer/counter 120MHz 0.1-2.1GHz

PHILIPS

Operation

Operating the Timer/Counter with the 2.3 GHz HF-input is done exactly in the same way as described in the Operators' Manual.

Specifications

Input C (Option PM 9619)

Frequency range: 100 MHz...2.3 GHz

Coupling: AC

Operating input voltage range:

20 mV_{rms}...12 V_{rms}; 100...300 MHz
10 mV_{rms}...12 V_{rms}; 300...2000 MHz
15 mV_{rms}...12 V_{rms}; 2000...2100 MHz
25 mV_{rms}...12 V_{rms}; 2100...2300 MHz 1)

AM Tolerance: 94% at max 100 kHz modulation frequency. Minimum signal must exceed minimum operating input voltage requirement

Input impedance:

50 Ω nominal

VSWR: Max 2.0:1 0.1...1.5 GHz
Max 2.5:1 1.5...2.0 GHz
Max 3.5:1 2.0...2.3 GHz

Max voltage without damage: 12 V_{rms};
overload protection with pin diodes

Ordering information

This is additional information to the ordering information on page 9-12 in the Operators' Manual.

When the new 2.3 GHz HF-input is to be ordered separately, order a PM 9619.

When a new counter is to be ordered the first digit after the stroke indicates the maximum frequency:

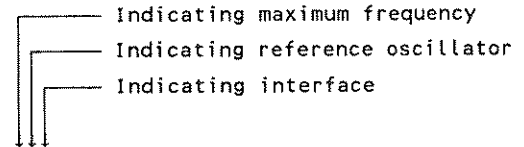

PM 6654C/XYZ

PM 6652C/0.. Is a PM 6652C Timer/Counter without HF-input.

PM 6652C/5.. Is a PM 6652C Timer/Counter with a 1.5 GHz HF-input, PM 9610.

PM 6652C/6.. Is a PM 6652C Timer/Counter with a 2.3 GHz HF-input, PM 9619.

PM 6654C/0.. Is a PM 6654C Timer/Counter without HF-input.

PM 6654C/5.. Is a PM 6654C Timer/Counter with a 1.5 GHz HF-input, PM 9610.

PM 6654C/6.. Is a PM 6654C Timer/Counter with a 2.3 GHz HF-input, PM 9619.

1) Only guaranteed when the PM 9619 is factory installed. When retro-fitted in the field, performance up to 2.1 GHz is guaranteed.

